

# MEDACTA SHOULDER SYSTEM

COMPLETE, CONVERTIBLE, INNOVATIVE



## Surgical Technique

Joint

Spine

Sports Med

REVERSE SHOULDER ARTHROPLASY



# INDEX

<b>1. INTRODUCTION</b>	<b>4</b>
1.1 Indications of use	4
1.2 Contraindications	4
1.3 Pre-Operative Planning	4
1.4 Surgical Approach	4
<b>2. HUMERAL DIAPHYSIS PREPARATION</b>	<b>5</b>
2.1 Humeral head resection	5
2.2 Medullary canal opening	5
2.3 Humeral canal preparation	5
2.4 Cut protection	6
<b>3. GLENOID PREPARATION AND BASEPLATE IMPLANT</b>	<b>7</b>
3.1 Exposure of the glenoid	7
3.2 Definition of glenoid centre, baseplate and glenosphere size	7
3.3 Glenoid baseplate reaming	8
3.4 Glenoid glenosphere reaming	8
3.5 Central hole drilling	8
3.6 Glenoid baseplate impaction	9
3.7 Screw hole preparation	9
3.8 Screw placement and locking	10
3.9 Trial glenosphere insertion	11
<b>4. HUMERAL METAPHYSIS PREPARATION</b>	<b>11</b>
4.1 Trial humeral diaphysis insertion	11
4.2 Humeral reaming	12
4.3 Trial Humeral Reverse Metaphysis insertion	12
4.4 Trial Humeral Reverse Liner insertion	12
4.5 Record values and remove trials	13
<b>5. GLENOSPHERE IMPLANT</b>	<b>14</b>
5.1 Glenosphere insertion and impaction	14
5.2 Glenosphere fixation	15
<b>6. HUMERAL IMPLANT</b>	<b>16</b>
6.1 Reverse Stem back table assembly	16
6.2 Reverse Stem insertion and impaction	16
6.3 Reverse Liner impaction	17
<b>7. IMPLANTS AND INSTRUMENTS NOMENCLATURE</b>	<b>18</b>
<b>8. COMPATIBILITY TABLE BASEPLATES - GLENOSPHERES</b>	<b>22</b>
<b>9. INSTRUMENTS COLOUR CODING INSTRUCTIONS</b>	<b>23</b>

## 1. INTRODUCTION

This surgical technique describes how to perform a reverse total shoulder arthroplasty implanting a pegged glenoid baseplate.

### CAUTION

Federal law (USA) restricts this device to sale distribution and use by or on the order of physician.

### 1.1 INDICATIONS OF USE

The Reverse Shoulder Prosthesis is indicated for treatment of humeral fractures and for primary or revision total shoulder replacement in patients with a grossly rotator cuff deficient shoulder joint, severe arthropathy or a previously failed joint replacement and a grossly rotator cuff deficient shoulder joint.

The patient's joint must be anatomically and structurally suited to receive the selected implant(s), and a functional deltoid muscle is necessary to use the device.

The glenoid baseplate is intended for cementless application with the addition of screws for primary stability.

### 1.2 CONTRAINDICATIONS

Total joint replacement is contraindicated in cases of:

- Local or systemic infection or sepsis
- Insufficient bone quality which may hinder the stability of the implant
- Muscular, neurological, or vascular deficiencies, which compromise the affected extremity
- Any concomitant disease and dependence that might affect the implanted prosthesis
- Materials (metals, etc.) sensitivity or allergy
- Loss of ligamentous structures that will prevent stabilisation and/or function of the device in vivo
- Non-functional deltoid muscle

### 1.3 PRE-OPERATIVE PLANNING

For planning purposes, standard X-rays are used. The recommended views are:

- antero-posterior view in internal rotation
- antero-posterior view in external rotation
- axillary view
- Morrison or Bernageau view

A CT-Scan with a three dimensional reconstruction is suggested for fracture cases. Further information on bone deficit and on muscle/capsule quality can be gathered with an MRI, recommended in osteoarthritis and osteonecrosis cases.

A neurological investigation could be helpful, for patient conditions assessment, especially in post-traumatic cases such as special cases of disabled shoulder.

Templates are used in all osteoarthritic and osteonecrosis cases; they can also be used in fracture cases but may not be sufficient for thorough planning, depending on the type of fracture.

The X-ray templates have a 115% scale; different magnifications and digital templates are also available on request.

### 1.4 SURGICAL APPROACH

The patient is usually placed in a beach chair position. Maintain free space for shoulder extension and adduction. Two surgical approaches are most frequently used for reverse shoulder prosthesis: delto-pectoral approach or deltoid split. Both can be used with the standard instrumentation provided, which has been optimized for delto-pectoral approach. The basic steps of the delto-pectoral approach are described below:

- Incision
  - an incision is made following the line of the delto-pectoral groove
  - a 10-15 cm incision is usual, but should be made in accordance with the surgical need and size of the patient
- Superficial dissection
  - the delto-pectoral fascia is encountered first; the cephalic vein is surrounded by a layer of fat and is used to identify the interval; the cephalic vein can be mobilised either medially or laterally, depending on patient factors and surgeon preference.
  - fibers of the deltoid are retracted laterally and the pectoralis major is retracted medially
- Deep dissection
  - the short head of the biceps and coracobrachialis arise from the coracoid process and are retracted medially. The musculocutaneous nerve enters the biceps 5-8cm distal to the coracoid process; care must be taken when retracting the conjoint tendon.
  - the fascia on the lateral side of the conjoint tendon is incised to reveal the subscapularis; external rotation stretches the subscapularis fibers. The subscapularis may be released from its insertion on the lesser tuberosity through the tendon or via an osteotomy
  - the capsule is then incised (as needed) to enter the joint

Exposure of the humeral head can be achieved through extension, external rotation and adduction.

This operating technique is independent of the chosen approach.

## 2. HUMERAL DIAPHYSIS PREPARATION

### 2.1 HUMERAL HEAD RESECTION

Expose the relevant landmarks such as the most medial insertion line of the supraspinatus, the bicipital groove and the estimated original location of the anatomical neck.

Position the extramedullary humeral cutting guide so that the resection is flush with the most medial insertion line of the supraspinatus and the shaft that follows the humeral diaphysis. This will result in an approximate inclination cut of 135°.

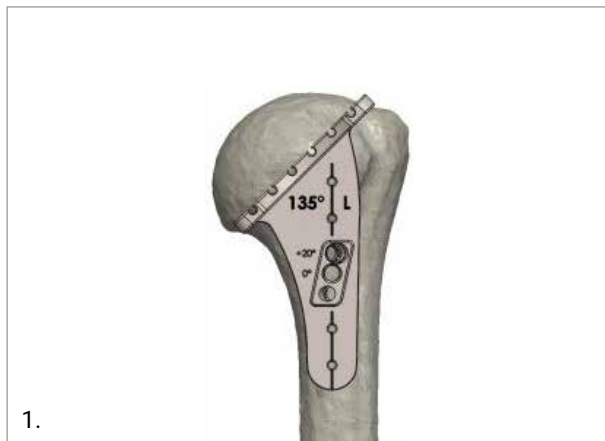

Check the cut inclination and retroversion using the Humeral Sickle and the Retroversion Rod. Once the desired position is found, fix the guide with two Ø2mm pins.

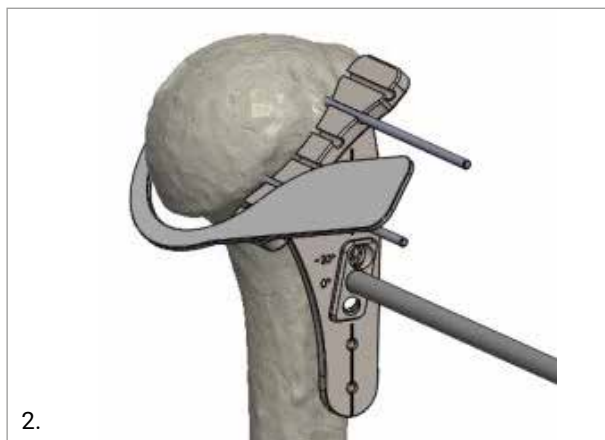

Perform the cut using an oscillating saw.

### 2.2 MEDULLARY CANAL OPENING

Connect the T-handle to the Medullary Canal Opener and use it to open the humeral canal. Start 8mm posterior to the deepest point of the bicipital groove and close to the medial insertion of the supraspinatus.



### 2.3 HUMERAL CANAL PREPARATION

Use the Intramedullary Reamers to size the distal medullary canal and the broaches to define the best fit proximally.

Connect the smallest reamer to the T-handle and start hand reaming. Incrementally increase the size until it fits the distal part of the medullary canal.



To avoid undersizing and varus positioning of the stem, remove the proximal metaphyseal cancellous bone using the Metaphyseal Chisel.



Attach the smallest Broach (size 6) to the Humeral Broach Handle: insert the lateral tip of the handle into the dedicated slot of the Broach and close the lever to insert the medial tip and lock the Broach. Screw the retroversion rod into the desired version hole and align the rod with the forearm fixed at 90 degrees to control the broach insertion alignment (0° and 20° options available).

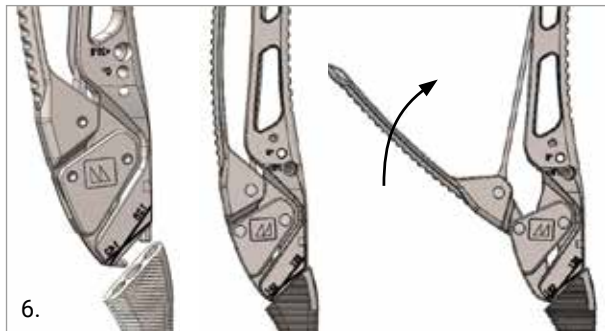

Start preparing the canal by lightly hammering on the anvil.

Stop hammering when the superior plane of the Broach is aligned with the humeral resection. Continue broaching with incrementally larger sizes.

The largest size that fits with its proximal portion fully seated in the canal determines the final stem size.



## WARNING

Do not try to introduce a Broach larger than the last Intramedullary Reamer. This might lead to a diaphyseal humeral fracture.

## 2.4 CUT PROTECTION

Place the Cut Protector on the resection plane. Choose the size which offers the best coverage. Fix it by screwing it to the broach using the HEX 3.5 screwdriver.



### 3. GLENOID PREPARATION AND BASEPLATE IMPLANT

#### 3.1 EXPOSURE OF THE GLENOID

Two different options are available to expose the glenoid:

1. External rotation and abduction of the humerus. This implies antero-inferior capsular resection and release of the coracohumeral ligament.
2. Alternatively, expose the glenoid trough humeral flexion, internal rotation and slight abduction, aiming at postero-inferior dislocation of the humerus. This implies circumferential capsular resection and release of the coracohumeral ligament.

#### 3.2 DEFINITION OF GLENOID CENTRE, BASEPLATE AND GLENSPHERE SIZE

Connect the Glenoid Multi-purpose Handle to the Reverse Glenoid Aiming Device. Position the assembled instrument on the glenoid vault so that the convex surface is in contact with the bone.

The presence of osteophytes may lead to incorrect positioning. It is highly recommended to remove them prior to positioning the K-wire.

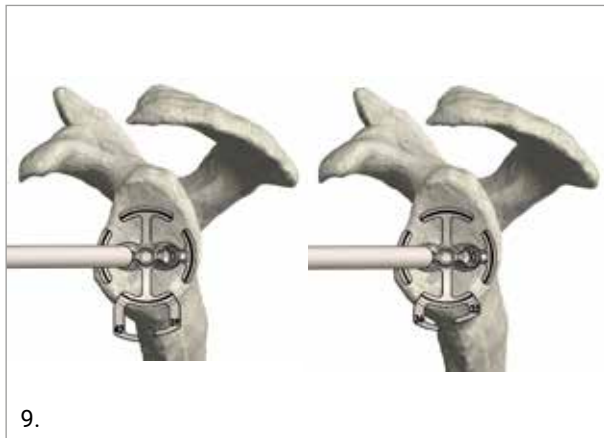

With the aiming device it is possible to evaluate the coverage of the Baseplate and the position of the Glenosphere:

- the black line marked on the circular rim represents the mid-size Baseplate (Ø24.5mm), while the outer and inner borders respectively show the dimension of the Ø27 and Ø22 Baseplates;
- the inferior profile of the available Glenosphere sizes is represented by the lower border of the "inferior legs".

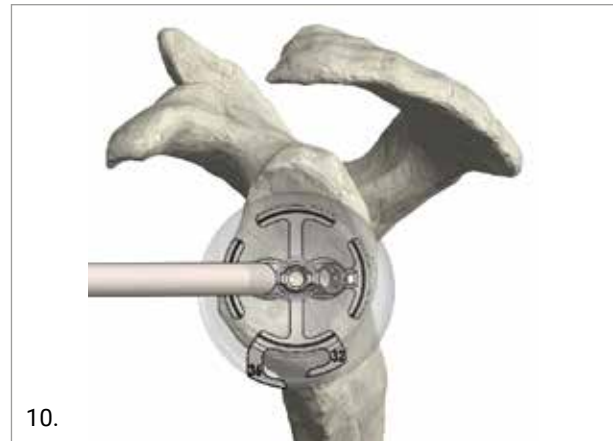

The position of the glenoid centre normally corresponds to the deepest point of the glenoid vault, where the best bone quality is normally found.

Once the glenoid centre, the baseplate size and the glenosphere size are defined, insert the Ø2.5mm K-wire through the central hole of the aiming device adjusting the drilling orientation to obtain the correct angle as planned.

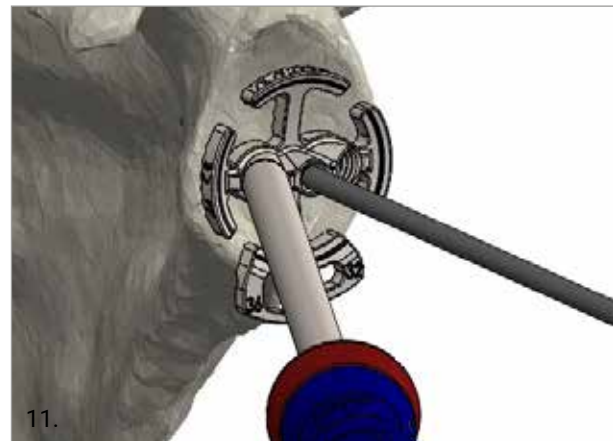

Remove the Reverse Glenoid Aiming device leaving the K-wire in place.

### 3.3 GLENOID BASEPLATE REAMING

Select the size of the Glenoid Reamer as previously determined. Slide it on the K-wire and connect it to the Reamer Handle as shown in the pictures below.

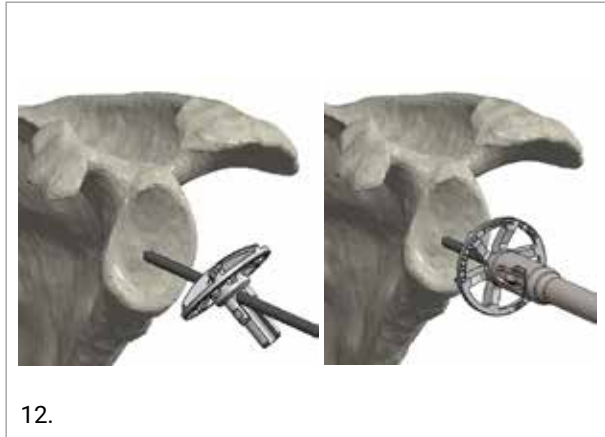

By visually checking the size of the reamer, the final evaluation of the size of the Baseplate to be implanted can be made.

Use a power tool to ream the glenoid to the desired depth considering that the aim is to normalise the version whilst avoiding excessive thinning of the subchondral bone plate.



### 3.4 GLENOID GLENOSPHERE REAMING

If desired, it is possible to temporarily remove the K-wire and place the Trial Glenosphere on the glenoid cavity to confirm the size of the Glenosphere.

Connect the corresponding size of Reamer for Glenosphere to the Reamer Handle. Slide the assembled instrument on the k-wire and manually ream the glenoid with the help of a T-handle.

The manual reaming is completed when a flat surface all around the baseplate is obtained and a full mechanical stop is reached.

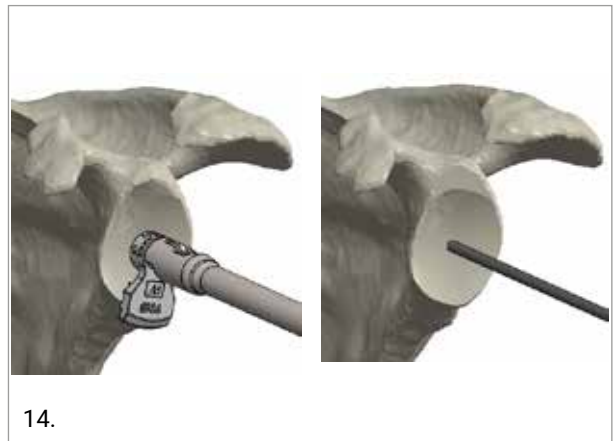

### 3.5 CENTRAL HOLE DRILLING

Select the desired length of the Central Peg Reamer for the Baseplate and connect it to the Reamer Handle. Slide the assembled reamer over the k-wire and use a power tool to ream the glenoid until the mechanical stop is reached. Remove the K-wire.

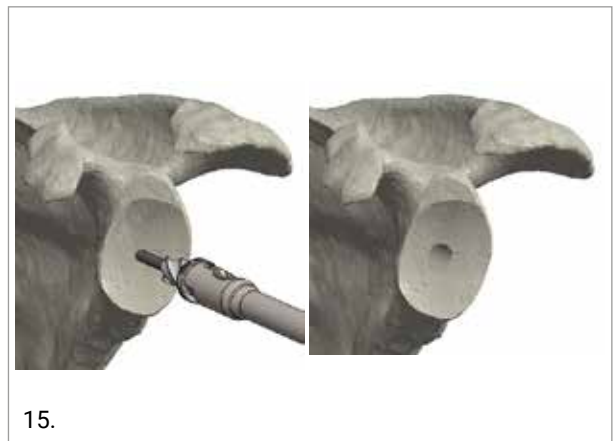



### 3.6 GLENOID BASEPLATE IMPACTION

Select the size of the Baseplate implant as previously defined. Connect the Baseplate Impactor Tip of the corresponding size to the Impactor Handle.

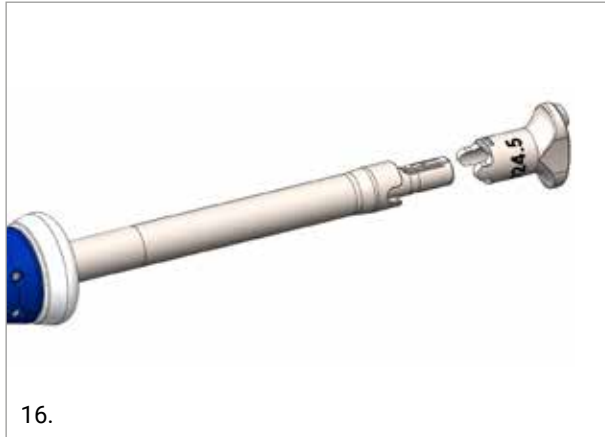

Slide the M5 Fixation Rod into the assembled Baseplate impactor.



Secure the Baseplate to the impactor by screwing the rod until fixed.

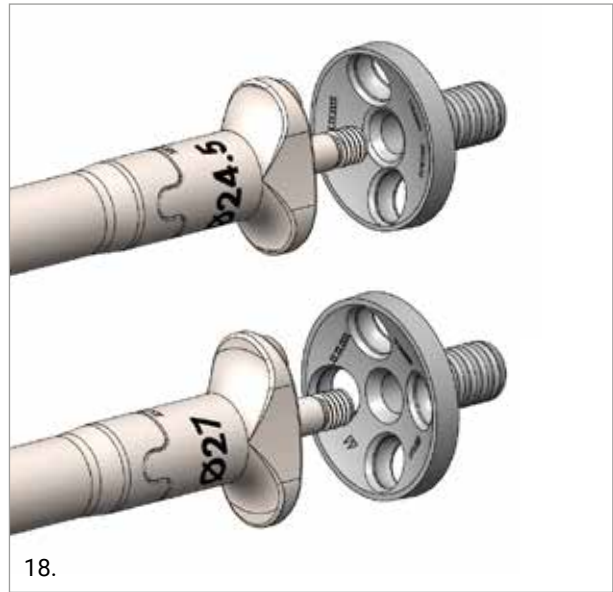

Rotate the Baseplate so that the two screws holes are oriented in the infero-superior direction of the glenoid. The Baseplate Impactor Tip shows the position of the screw holes. Impact the Baseplate to the bone until a full stop is reached.

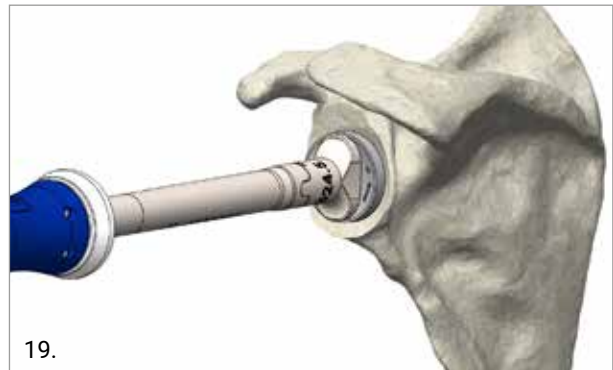

### 3.7 SCREW HOLE PREPARATION

Connect the Glenoid Multi-purpose Handle to the Drill Guide for Polyaxial Screws.

Insert the Drill Guide for Polyaxial Screws into one of the spherical seats of the Baseplate. Orient the drill guide in the desired direction, considering that the guide allows for 15° of freedom in every direction. Insert the Drill Bit for Polyaxial Screws into the guide and drill a hole to the desired depth using the markings as a reference.

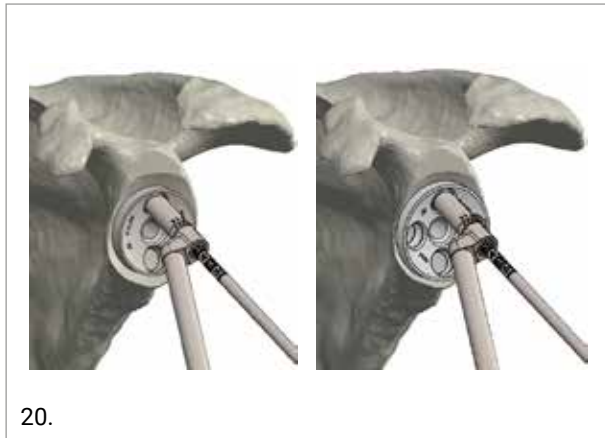

It is also possible to use the Depth Gauge to check the depth of the drilled holes.

Repeat the procedure for every screw used. The superior and the inferior screws are considered mandatory whilst the anterior and the posterior screws are optional.

**NOTE:** anterior and posterior screw holes are only present in the 27mm baseplate.

### 3.8 SCREW PLACEMENT AND LOCKING

Choose the desired screw length, as previously measured. Assemble the Glenoid Polyaxial Screwdriver Modular Tip with the Reamer Handle and then to the T-handle. Connect the screw head to Glenoid Polyaxial Screwdriver Modular Tip as shown below:

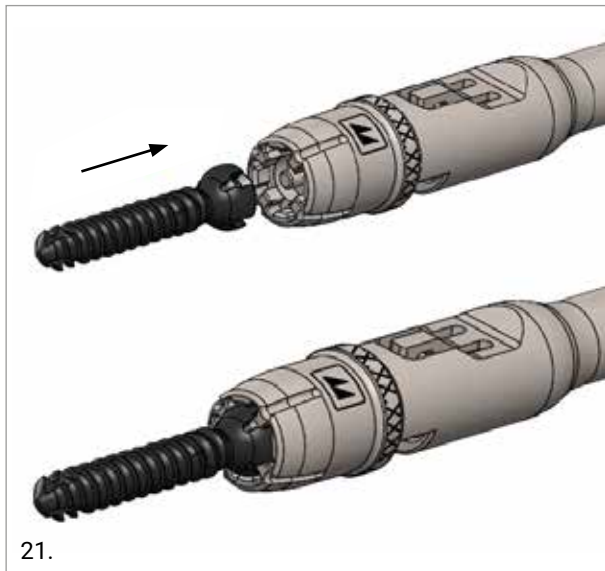

Insert the screw into the bone.

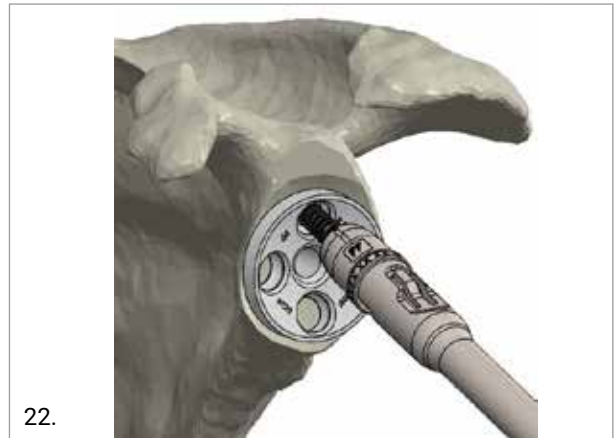

Continue to insert the screw until the Glenoid Polyaxial Screwdriver Modular Tip disconnects from the screw head. Use the Glenoid Polyaxial Screwdriver to fully sit the head of the screw in the baseplate hole.

Assemble the Modular 2 N-m Torque Limiting screwdriver with the Modular Screwdriver - T10 tip. Use this instrument to lock the screw by tightening the inner screw until the Torque Limiter Screwdriver slips. Repeat the procedure for every screw used.



Glenoid polyaxial non-locking screws can be used as an alternative option for the Baseplate fixation.

All the previous surgical steps remain unchanged (up to § 3.7). Once the desired screw length is chosen, connect the screw head to the Screwdriver T15 for Glenoid Non-locking Screws as shown below.

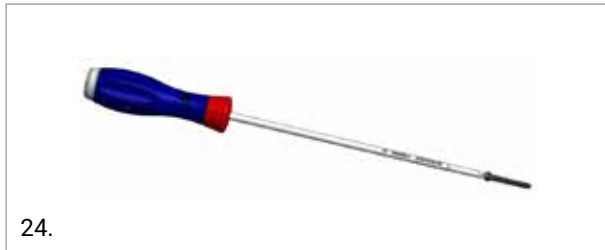

Insert the Glenoid Polyaxial Non-locking Screw into the bone and use the Screwdriver to fully sit the screw head in the dedicated seat of the Glenoid Baseplate.

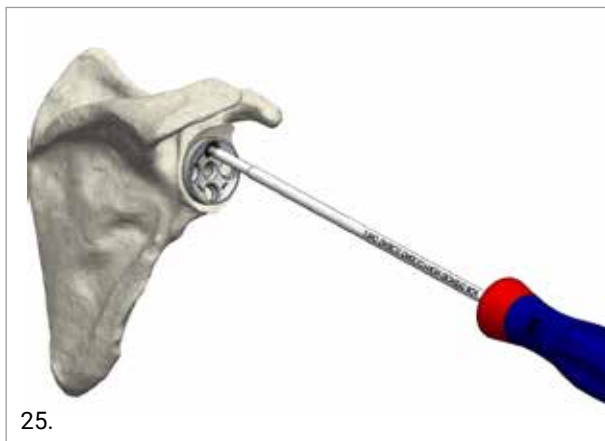

Repeat the procedure for every screw used till the Baseplate is completely compressed on the prepared glenoid vault.

### 3.9 TRIAL GLENOSPHERE INSERTION

Insert the Trial Glenosphere into the Baseplate and orient it according to the anatomy of the glenoid using forceps.

Select the largest size of the Trial Glenosphere that fits the patient's anatomy. Lock the embedded screw of the Trial Glenosphere to fix its position.

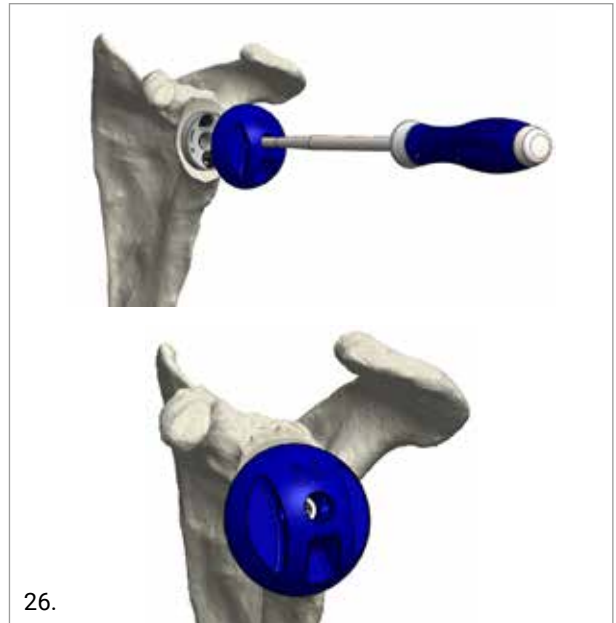

## 4. HUMERAL METAPHYSIS PREPARATION

### 4.1 TRIAL HUMERAL DIAPHYSIS INSERTION

Remove the Humeral Cut Protector by unscrewing it from the broach using the HEX 3.5 screwdriver. Remove the broach by using the Humeral Broach Handle. Take the Trial Humeral Diaphysis of the same size as the last broach used to prepare the canal, connect it to its inserter by rotating the knob clockwise and insert it into the humeral canal until the marked line is flush with the humeral resection.

Screw the retroversion rod into the desired version hole and align the rod with the forearm fixed at 90 degrees to check the Trial Humeral Diaphysis insertion (0° and 20° options available).

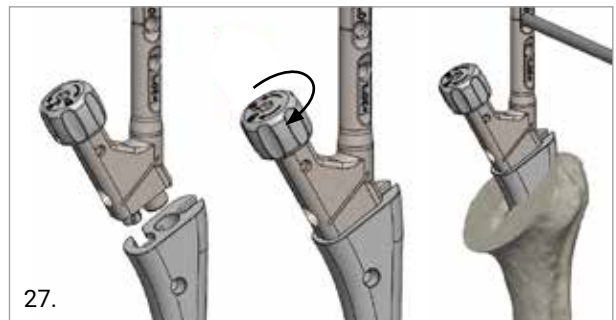

Unlock and extract the inserter.

**4.2 HUMERAL REAMING**

Connect the Humeral Reaming Guide to the Trial Humeral Diaphysis.

Assemble the Reamer for Reverse Metaphysis to the Reamer Shaft. Slide it over the Reaming Guide and ream the humerus using a power tool until the mechanical stop is reached.

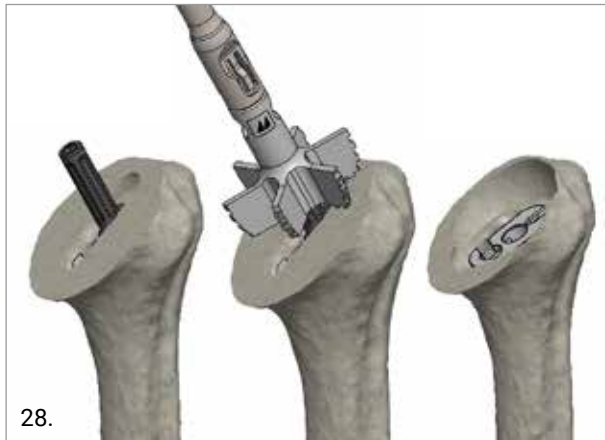

**4.3 TRIAL HUMERAL REVERSE METAPHYSIS INSERTION**

Connect the Trial Humeral Reverse Metaphysis to the Trial Humeral Diaphysis and fix it with the embedded screw.



**CAUTION**

The Trial Humeral Reverse Metaphysis is correctly oriented when the “Medial” mark is in the direction of the calcar region and the indexing pin is lateral.

**4.4 TRIAL HUMERAL REVERSE LINER INSERTION**

Insert the Trial Humeral Reverse Liner of the same size of the selected Trial Glensphere (cf. 3.9) into the Trial Humeral Reverse Metaphysis.

Align the marking on the outer surface of the trial reverse liner with the medial line on the trial reverse metaphysis to obtain an inclination of 155°. Insert the Trial Humeral Reverse Liner in the opposite orientation (180° rotated) to get an inclination of 145°.



Reduce the joint and test the kinematics, especially stability and mobility.

Make sure that there is no early glenohumeral impingement, “hinging-open” in adduction, extension, internal and external rotation.

Should the shoulder be unstable, height correction components can be selected. The following table shows the possible height options of both the Reverse Metaphysis and Reverse Liner:

**AVAILABLE HEIGHT OPTIONS**

		REVERSE LINER		
		mm	+0	+3
REVERSE METAPHYSIS	+0	+0	+3	+6
	+9	+9	+12	+15

If any retroversion correction is needed, +20°Right/-20°Left and +20°Left/-20°Right options can be used, for both +0mm and +9mm height options.

#### 4.5 RECORD VALUES AND REMOVE TRIALS

Record the height and inclination of the trial reverse liner.  
Record the height and retroversion of the Trial Reverse Metaphysis.

Snap the Trial Reverse Liner Extractor into the Trial Reverse Liner and pull the instrument to remove the trial.

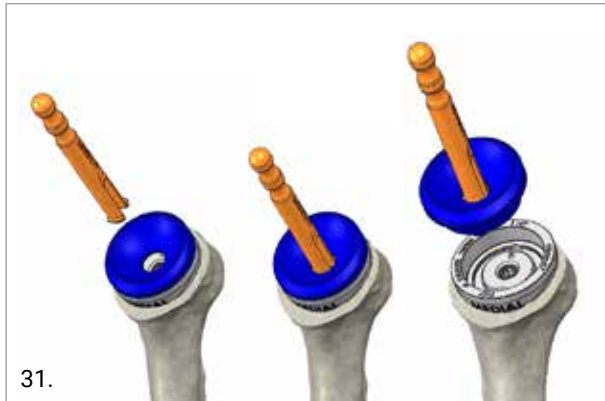

Connect the Reverse Stem Inserter to the assembled trial reverse stem according to the following procedure.

Slide the Reverse Stem Inserter into the Trial Reverse Metaphysis aligning the "1" line of the instrument with the medial line of the implant.



Push the handle down towards the implant and, holding it down, rotate the instrument clockwise aligning the "2" line to the medial line of the implant. The instrument is correctly connected when a snap is felt.

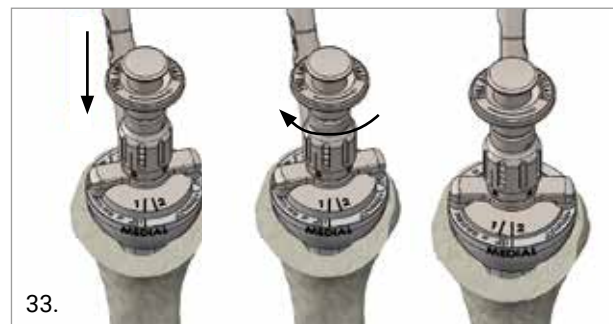

Remove the trial stem from the bone.

Remove the instrument by pushing the central knob whilst pulling the cap back and rotating it counterclockwise (from position 2 to position 1).

Record the size and the orientation of the Trial glenosphere.  
Remove the Trial glenosphere from the Baseplate.

## 5. GLENOSPHERE IMPLANT

### 5.1 GLENOSPHERE INSERTION AND IMPACTION

Connect the Glenosphere Guide to the retentive tip of the HEX 3.5 screwdriver.  
Tighten the Glenosphere Guide onto the Baseplate.



Screw the glenosphere positioner to the selected glenosphere.

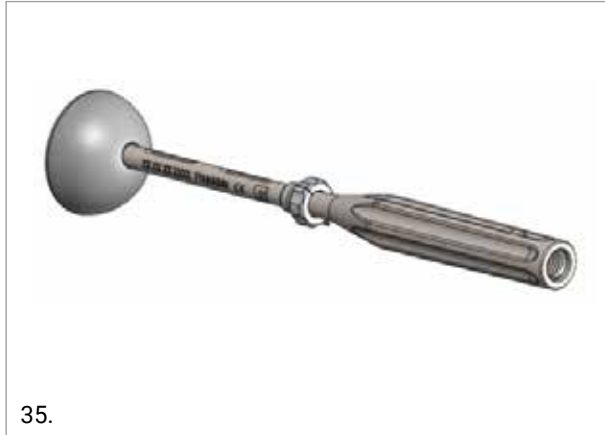

Push the eccentricity pointer towards the glenosphere to free it.

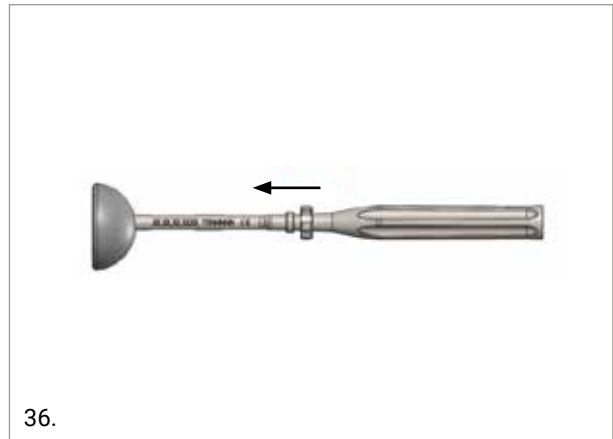

Align it with the glenosphere eccentricity referencing to the line marked on its back surface. Then pull it backwards to fix it

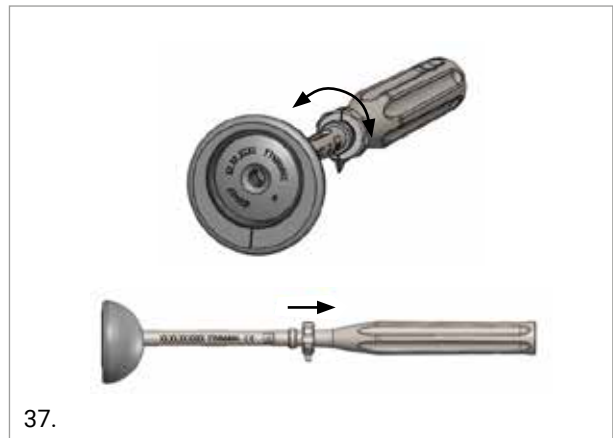

Position the glenosphere on the baseplate letting the previously inserted Glenosphere Guide align the two components. Gently impact the Glenosphere.

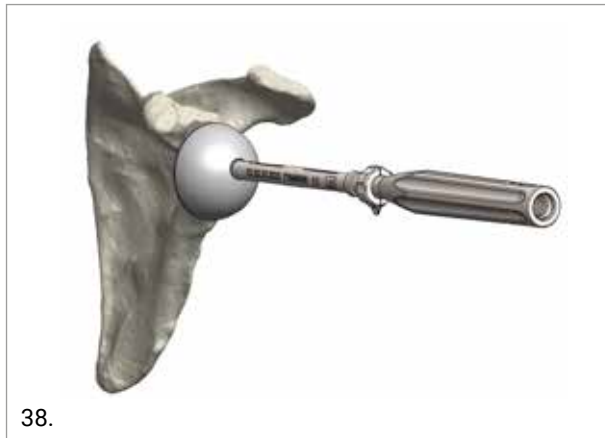

If needed, the glenosphere eccentricity can be corrected with the glenosphere orienter.



Once a correct alignment of the eccentricity is achieved, gently impact the glenosphere.

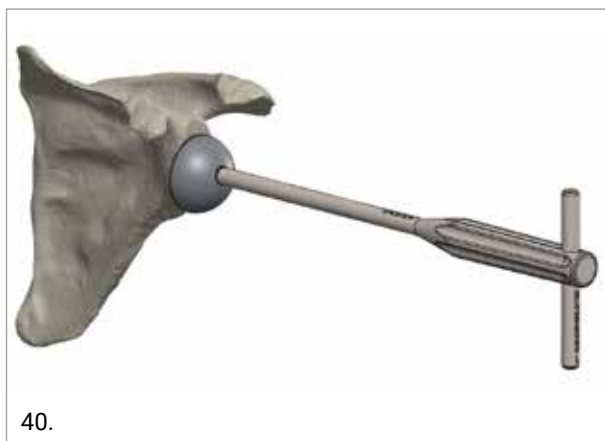

Assemble the glenosphere impactor tip to the multipurpose handle and use it for the final impaction of the glenosphere.

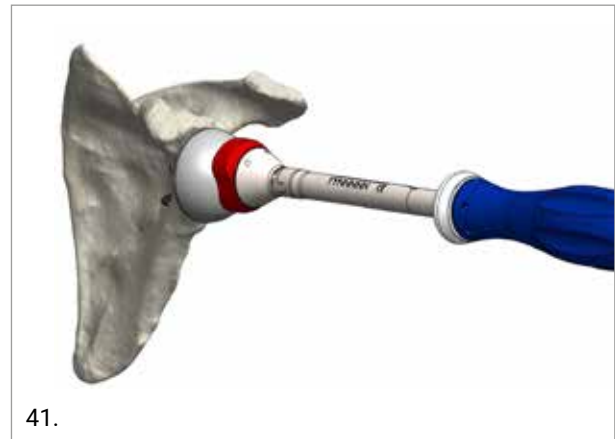

## 5.2 GLENSPHERE FIXATION

### **WARNING**

Remove the Glenosphere Guide from the baseplate.

Connect the Glenosphere screw to the retentive tip of the torque limiting screwdriver T15 3 N-m. Slide it into the Glenosphere and tighten it until the screwdriver slips.

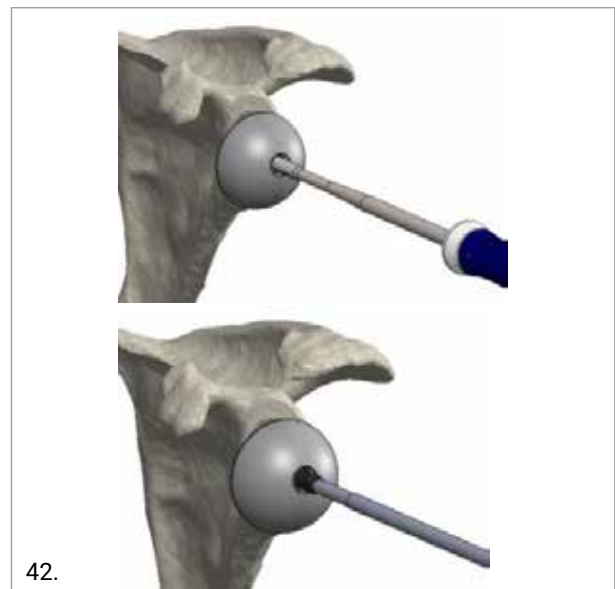

## 6. HUMERAL IMPLANT

### 6.1 REVERSE STEM BACK TABLE ASSEMBLY

Assemble the Backtable stem adapter of the selected Humeral Diaphysis size with the Backtable Assembly Block, then insert the Humeral Diaphysis into the hole. Position the Reverse Metaphysis of the selected height and retroversion on the Humeral Diaphysis.

#### CAUTION

The Reverse Metaphysis is correctly oriented when the 155° mark is in the direction of the calcar region and the indexing pin is lateral and correctly inserted in the lateral groove of the Humeral Diaphysis.

Insert the Reverse Metaphysis Screw and tighten it with the Torque limiting screwdriver T20 6 N·m until the screwdriver slips.



43.

#### WARNING

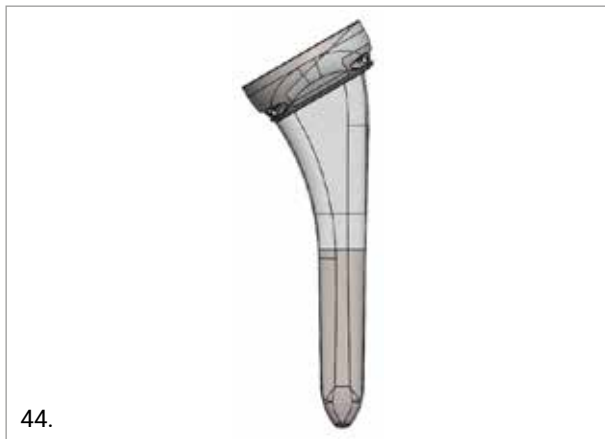

44.

Carefully check the correct assembly of the Reverse Metaphysis onto the Humeral Diaphysis: no space shall be present between the two assembled components

### 6.2 REVERSE STEM INSERTION AND IMPACTION

Connect the Reverse Stem Inserter to the assembled reverse stem according to the following procedure.

Slide the Reverse Stem Inserter into the Reverse Metaphysis aligning the "1" line of the instrument with the medial line of the implant.

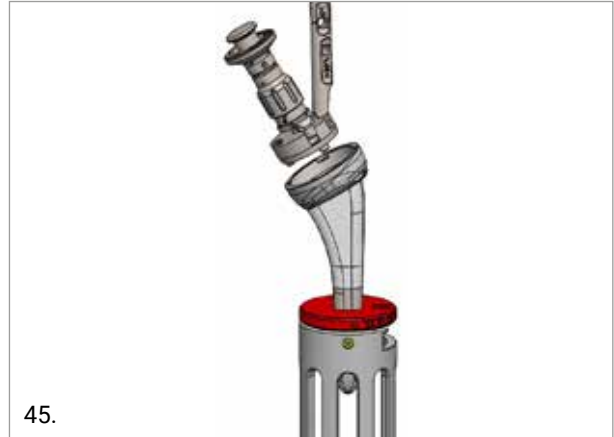

45.

Push the handle down towards the implant and, holding it down, rotate the instrument clockwise aligning the "2" line to the medial line of the implant. The instrument is correctly connected when a snap is felt.

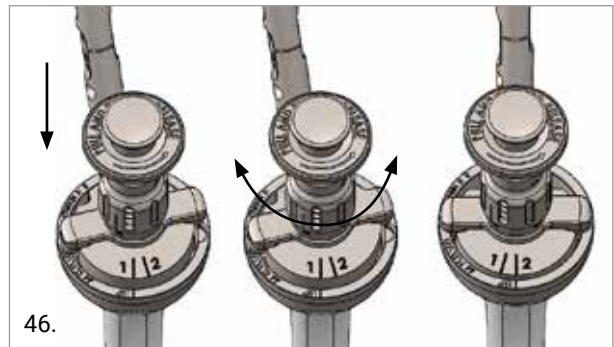

46.

In case it is difficult to remove the stem from its slot, insert the Backtable Assembly Block in the Backtable Stem Removal Device and screw both components. This will push the stem up and release it from the block.



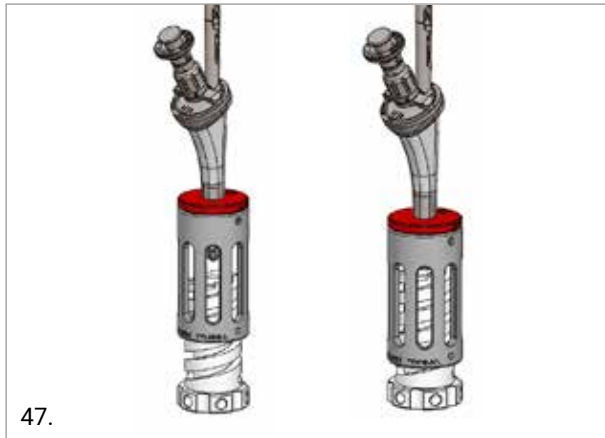

47.

Where a cemented humeral diaphysis is used, insert the appropriately sized cement restrictor into the humeral canal approximately 1 cm below the distal tip of the humeral stem. Brush, irrigate and dry the humeral canal before bone cement is pressurised. Mix the bone cement according to the manufacturer's instructions. Extrude the bone cement into the humeral canal, distal to proximal, using a retrograde technique. When the bone cement has reached a dough-like consistency, insert the cemented humeral diaphysis into the humerus by gently tapping the instrument handle. Upon completion, remove the instrument handle and any remaining excess bone cement. Cemented humeral diaphysis can be implanted line to line (cemented humeral diaphysis of the same size as the final broach size), one size down (cemented humeral diaphysis one size smaller than the final broach size, providing 1.2 mm diametrical cement mantle) or two sizes down (cemented humeral diaphysis two sizes smaller than the final broach size, providing 2.4 mm diametrical cement mantle) according to the surgeon's preference.

For a cementless humeral diaphysis implantation, gently tap on the instrument handle to fix the position of the selected cementless humeral diaphysis into the humerus.

Screw the retroversion rod into the desired version hole and align the rod with the forearm fixed at 90 degrees to control the stem insertion alignment (0° and 20° options available).

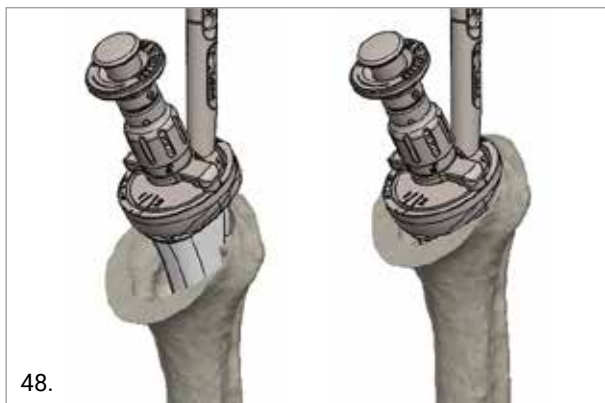

48.

Remove the instrument by pushing the central knob whilst pulling the cap back and rotating it counter clockwise (from position 2 to position 1).

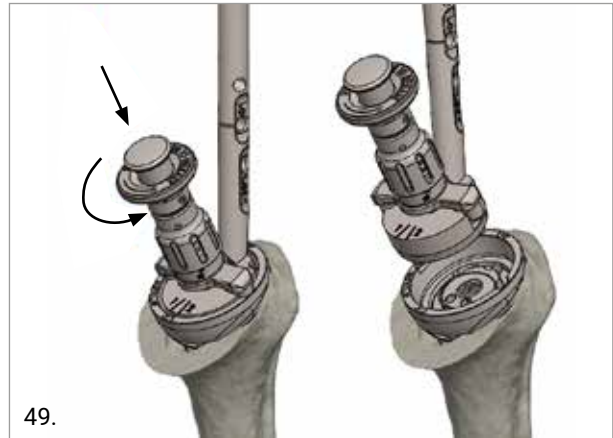

49.

### 6.3 REVERSE LINER IMPACTION

Connect the Reverse Liner Impactor Tip to the Impactor Handle.



50.



Position the Reverse Liner as defined in the trialling phase and impact it with the reverse liner impactor.



51.

7. IMPLANTS AND INSTRUMENTS NOMENCLATURE

**IMPLANTS**

REFERENCE	DESCRIPTION	PICTURE
04.01.0001	STD Humeral diaphysis - cementless - 6	
04.01.0002	STD Humeral diaphysis - cementless - 7	
04.01.0003	STD Humeral diaphysis - cementless - 8	
04.01.0004	STD Humeral diaphysis - cementless - 9	
04.01.0005	STD Humeral diaphysis - cementless - 10	
04.01.0006	STD Humeral diaphysis - cementless - 11	
04.01.0007	STD Humeral diaphysis - cementless - 12	
04.01.0008	STD Humeral diaphysis - cementless - 13	
04.01.0009	STD Humeral diaphysis - cementless - 14	
04.01.0010	STD Humeral diaphysis - cementless - 15	
04.01.0011	STD Humeral diaphysis - cementless - 16	
04.01.0012	STD Humeral diaphysis - cemented - 6	
04.01.0014	STD Humeral diaphysis - cemented - 8	
04.01.0016	STD Humeral diaphysis - cemented - 10	
04.01.0018	STD Humeral diaphysis - cemented - 12	
04.01.0020	STD Humeral diaphysis - cemented - 14	
04.01.0022	STD Humeral diaphysis - cemented - 16	

**IMPLANTS**

REFERENCE	DESCRIPTION	PICTURE
04.01.0110	Humeral reverse metaphysis +0mm/0°	
04.01.0111	Humeral reverse metaphysis +9mm/0°	
04.01.0112	Humeral reverse metaphysis +0mm/+20°L *	
04.01.0113	Humeral reverse metaphysis +9mm/+20°L *	
04.01.0114	Humeral reverse metaphysis +0mm/+20°R *	
04.01.0115	Humeral reverse metaphysis +9mm/+20°R *	

\*On demand



## IMPLANTS

REFERENCE	DESCRIPTION	PICTURE
04.01.0116	Humeral reverse HCPE liner Ø32/+0mm *	
04.01.0117	Humeral reverse HCPE liner Ø32/+3mm *	
04.01.0118	Humeral reverse HCPE liner Ø32/+6mm *	
04.01.0119	Humeral reverse HCPE liner Ø36/+0mm	
04.01.0120	Humeral reverse HCPE liner Ø36/+3mm	
04.01.0121	Humeral reverse HCPE liner Ø36/+6mm	
04.01.0122	Humeral reverse HCPE liner Ø39/+0mm	
04.01.0123	Humeral reverse HCPE liner Ø39/+3mm	
04.01.0124	Humeral reverse HCPE liner Ø39/+6mm	
04.01.0125	Humeral reverse HCPE liner Ø42/+0mm	
04.01.0126	Humeral reverse HCPE liner Ø42/+3mm	
04.01.0127	Humeral reverse HCPE liner Ø42/+6mm	

**NOTE:** UHMWPE implants should be stored for at least three hours at 20° C (+/- 3°C) before the operation

\*On demand

## IMPLANTS

REFERENCE	DESCRIPTION	PICTURE
04.01.0148	Glenoid baseplate Ø22x15 *	
04.01.0149	Glenoid baseplate Ø22x25 *	
04.01.0150	Glenoid baseplate Ø22x35 *	
04.01.0151	Glenoid baseplate Ø24.5x15	
04.01.0152	Glenoid baseplate Ø24.5x25	
04.01.0153	Glenoid baseplate Ø24.5x35	
04.01.0154	Glenoid baseplate Ø27x15	
04.01.0155	Glenoid baseplate Ø27x25	
04.01.0156	Glenoid baseplate Ø27x35	

\*On demand

**IMPLANTS**



REFERENCE	DESCRIPTION	PICTURE
04.01.0157	Glenoid polyaxial locking screw - L14	
04.01.0158	Glenoid polyaxial locking screw - L18	
04.01.0159	Glenoid polyaxial locking screw - L22	
04.01.0160	Glenoid polyaxial locking screw - L26	
04.01.0161	Glenoid polyaxial locking screw - L30	
04.01.0162	Glenoid polyaxial locking screw - L34	
04.01.0163	Glenoid polyaxial locking screw - L38	
04.01.0164	Glenoid polyaxial locking screw - L42	
04.01.0165	Glenoid polyaxial locking screw - L46	
04.01.0166	Glenoid polyaxial locking screw - L50	
04.01.0194	Glenoid polyaxial non-locking screw – L14	
04.01.0195	Glenoid polyaxial non-locking screw –L18	
04.01.0196	Glenoid polyaxial non-locking screw –L22	
04.01.0197	Glenoid polyaxial non-locking screw –L26	
04.01.0198	Glenoid polyaxial non-locking screw –L30	
04.01.0199	Glenoid polyaxial non-locking screw –L34	
04.01.0200	Glenoid polyaxial non-locking screw –L38	
04.01.0201	Glenoid polyaxial non-locking screw –L42	
04.01.0202	Glenoid polyaxial non-locking screw –L46	
04.01.0203	Glenoid polyaxial non-locking screw –L50	

**IMPLANTS**

REFERENCE	DESCRIPTION	PICTURE
04.01.0167	Glenosphere 32xØ22*	
04.01.0168	Glenosphere 36xØ22*	
04.01.0178	Glenosphere 32xØ24.5*	
04.01.0169	Glenosphere 36xØ24.5	
04.01.0170	Glenosphere 39xØ24.5	
04.01.0171	Glenosphere 42xØ24.5	
04.01.0172	Glenosphere 36xØ27	
04.01.0173	Glenosphere 39xØ27	
04.01.0174	Glenosphere 42xØ27	

\*On demand

## IMPLANTS

REFERENCE	DESCRIPTION	PICTURE
04.01.0176	Reverse metaphysis screw	
04.01.0177	Glenosphere screw	









## INSTRUMENTS

REFERENCE	DESCRIPTION	PICTURE
04.01S.310US	Medacta Shoulder General	
04.01S.311US	Medacta Shoulder Humerus	
04.01S.312	Medacta Shoulder Reverse	

**NOTE:** All the above instruments sets include motorized instruments with Zimmer-Hall connection, in alternative:  
 04.01S.310: motorized instruments with AO connection  
 04.01S.311: motorized instruments with AO connection



**8. COMPATIBILITY TABLE BASEPLATES - GLENOSPHERES**

The table below illustrates the possible combinations between the glenoid baseplates and the glenosphere, please follow this table to build your implant construct:

	Ø 32	Ø 36	Ø 39	Ø 42
Baseplate Ø 22			-	-
Baseplate Ø 24.5				
Baseplate Ø 27	-			

## 9. INSTRUMENTS COLOUR CODING INSTRUCTIONS

Colour Coding for Instruments\*:

- Humeral Instruments: all the dedicated humeral instruments have a yellow tag 
- Glenoid Instruments: all the dedicated glenoid instruments have a red tag 
- General Instruments: all the multipurpose instruments have a white tag 

\*= except for torque limiting screwdrivers

Part numbers subject to change.

### NOTE FOR STERILIZATION

The instrumentation is not sterile upon delivery. Instruments must be cleaned before use and sterilized in an autoclave respecting the US regulations, directives where applicable, and following the manufactures instructions for use of the autoclave. For detailed instructions please refer to the document "Recommendations for cleaning decontamination and sterilisation of Medacta International orthopaedic devices" available at [www.medacta.com](http://www.medacta.com).



---

**REDEFINING BETTER  
IN ORTHOPAEDICS  
AND NEUROSURGERY**

---

MEDACTA.COM



**Medacta International SA**  
Strada Regina - 6874 Castel San Pietro - Switzerland  
Phone +41 91 696 60 60 - Fax +41 91 696 60 66  
info@medacta.ch

Find your local dealer at: [medacta.com/locations](http://medacta.com/locations)

All trademarks and registered trademarks are the property of their respective owners.  
This document is intended for the US market.

Reverse Shoulder System  
Surgical Technique

ref: 99.81.12US  
rev. 03

Last update: November 2018