

# **Mectalif** ANTERIOR

ANTERIOR LUMBAR INTERBODY FUSION DEVICE

MODULAR DESIGN OFFERS FREEDOM OF CHOICE

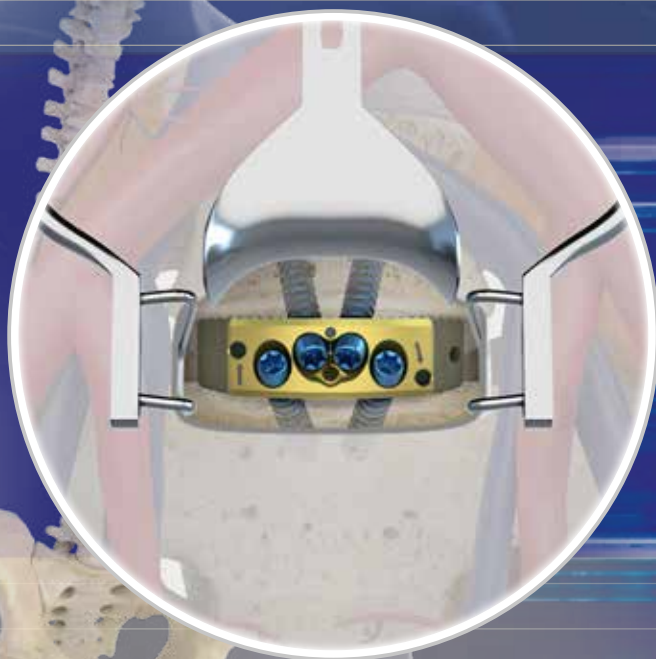

## Surgical Technique

Joint

**Spine**

Sports Med



# INDEX

<b>1. INTRODUCTION</b>	<b>4</b>
1.1 Material & Marker	5
1.2 Indications	5
1.3 Contraindications	6
1.4 Preoperative Planning	6
1.5 Surgical Approach	6
<b>2. PREPARATION</b>	<b>7</b>
2.1 Anterior Access and Approach	7
2.2 Discectomy and Endplate Preparation	7
2.3 Trial Selection	7
2.4 Implant Selection & Assembly	8
<b>3. IMPLANT INSERTION</b>	<b>9</b>
3.1 Implant Graft Packing	9
3.2 Standard Implant Preparation & Insertion	9
3.3 Alternative "Flush Plate" Implant Preparation & Insertion	10
<b>4. SCREW INSERTION</b>	<b>11</b>
4.1 Free Hand Technique	11
<b>5. FLUSH CONSTRUCT - GUIDED TECHNIQUE</b>	<b>14</b>
<b>6. IMPLANT REMOVAL</b>	<b>16</b>
<b>7. IMPLANTS NOMENCLATURE</b>	<b>17</b>

## 1. INTRODUCTION

The design incorporates the benefits of an anterior plate and a radiolucent interbody spacer. The four plate designs that can be used are designed to accommodate specific anatomic requirements. The system is completely modular. It offers a cage with 3 different footprints, 4 degrees of lordosis and 5 heights, to which the surgeon can connect any of the four profile plates that is required for the specific pathology the surgeon wants to treat.

1. The cage is offered in TiPEEK material and has 4 optional lordosis angles in 5deg, 10deg, 15deg and 20deg.



2. The MectaLIF Anterior Stand-Alone - Flush design creates a zero-profile construct with minimum geometrical impact.



3. The Lateral Plate design provides the option to insert the cage & plate combination in an anterior-lateral approach in order to minimize the manipulation of the arteries.



4. The Long Plate can be used in levels where the surgeon requires a longer plate support such as levels L2-L3-L4-L5.



5. The Hybrid Plate merges the properties of the Flush and the Long Plate by offering superior cranial stability and a caudal flush profile.



6. The screws are offered in 2 diameters and 4 lengths in order to provide multiple options, including a "rescue" option, to the surgeon.

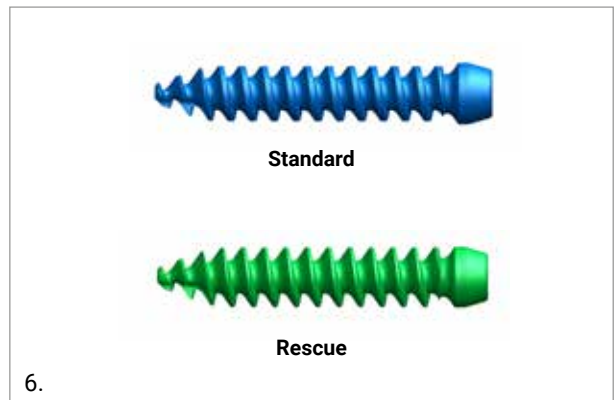

### MectaLIF Anterior Simple Plate Cage

The MectaLIF Anterior Simple Plate Cage is an interbody fusion device which can be used in combination with supplemental posterior fixation.

The design incorporates the benefits of a modular anterior plate and a radiolucent interbody spacer which is offered with 2 different footprints, 3 degrees of lordosis and 5 heights to accommodate several patients anatomy.



### 1.1 MATERIAL & MARKER

The cage is offered in TIPEEK material (Titanium Coated PEEK).

- Biocompatible radiolucent PEEK (Polyetheretherketone) allows a clear assessment of bony fusion through the device. PEEK provides an excellent modulus of elasticity and load sharing attributes
- Titanium coating

Posterior and lateral Tantalum marker pins allow for clear radiographic visualization of the device in the coronal and sagittal planes.



- Titanium Screws
- Titanium Plate

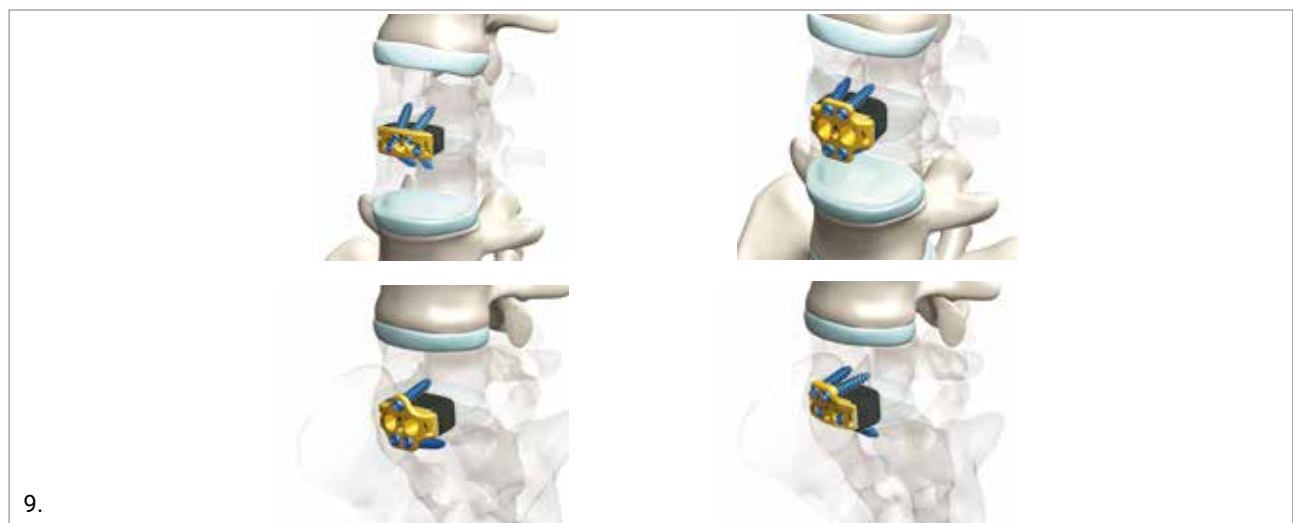

## 1.2 INDICATIONS

The MectaLIF Anterior is an interbody fusion device indicated for use in patients with degenerative disc disease (DDD) at one or two contiguous levels from L2 to S1.

These DDD patients may also have up to Grade I spondylolisthesis or retrolisthesis at the involved level(s). The interior of the spacer component of the MectaLIF Anterior can be packed with autograft or autologous bone graft.

DDD is defined as back pain of discogenic origin with degeneration of the disc confirmed by history and radiographic studies.

These patients should be skeletally mature and have had six months of non-operative treatment. These patients may have had a previous non-fusion spinal surgery at the involved spinal level(s).

The MectaLIF Anterior Stand-Alone system is intended to be used with bone screws provided and requires no additional supplementary fixation.

The MectaLIF Anterior Simple requires additional supplementary fixation such as pedicle screws and rods or lumbar anterior plate system.

## 1.3 CONTRAINDICATIONS

The use of the MectaLIF Anterior System is contraindicated in the following cases:

- Active infectious process or significant risk of infection (immunocompromise)
- Signs of local inflammation
- Fever or leukocytosis
- Morbid obesity
- Pregnancy
- Mental illness

- Grossly distorted anatomy caused by congenital abnormalities
- Any other medical or surgical condition which would preclude the potential benefit of spinal implant surgery, such as the presence of congenital abnormalities, elevation of sedimentation rate unexplained by other diseases, elevation of white blood count (WBC), or a marked left shift in the WBC differential count
- Suspected or documented metal allergy or intolerance
- Any case not needing a fusion
- Any case where the implant components selected for use would be too large or too small to achieve a successful result
- Any patient having inadequate tissue coverage over the operative site or inadequate bone stock or quality
- Any patient in which implant utilization would interfere with anatomical structures or expected physiological performance
- Any patient unwilling to follow postoperative instructions
- Any case not described in the indications

Although not absolutely contraindicated, conditions to be considered as potential factors for not using this device include severe bone resorption, osteomalacia, severe osteoporosis.

## 1.4 PREOPERATIVE PLANNING

Prior to any surgical implantation of the device, it is critical to evaluate the patient's pre-operative MRI and/or CT to template and determine the most appropriate size and type of implant to be used in order to match the patient's anatomy.

## 1.5 SURGICAL APPROACH

The surgical approach depends on which level needs to be treated.

The MectaLIF Anterior interbody fusion device system is indicated for use via the anterolateral surgical approach as well as the anterior retroperitoneal approach.

## 2. PREPARATION

The MectaLIF Anterior interbody fusion device systems are intended to be implanted by an anterior approach.

The Long, L5-S1 plate as well as the Flush and Hybrid plate can be used to provide the surgeon the possibility to choose the most appropriate implant.

### 2.1 ANTERIOR ACCESS AND APPROACH

Locate the correct operative level and incision location by taking a lateral flourescopic view while holding a straight metal object, such as a guide wire, at the side of the patient. This will ensure that the incision and exposure allow direct visualization of the vertebral segment. The screws of the MectaLIF Anterior Stand-Alone Flush, L5-S1, Hybrid and Long Plate must be inserted from a direct anterior approach.

### 2.2 DISCECTOMY AND ENDPLATE PREPARATION

Expose the disc space to create sufficient space on either side of the vertebral midline. This allows for safe insertion of the implant, without interference from possible adjacent soft tissue. Good preparation of the disc space is vital prior to implantation. Medacta provides optional Auxiliary Disc Prep Instruments to help with the disc preparations. Remove the cartilage endplates to bleeding bone, do not compromise the integrity of the bony endplates. An additional Distractor or a Modular Padde Distractor are available if distraction or remobilization is required. Check if the Vertebral Body Distractor is safely positioned with an intraoperative lateral X-ray.



### 2.3 TRIAL SELECTION

Select the Flush Profile Trial that is most suitable for the disc space. Check the appropriate footprint and lordotic angle. Attach it to the Straight Inserter and lock tightly by turning the wheel at the end of the Inserter Handle.

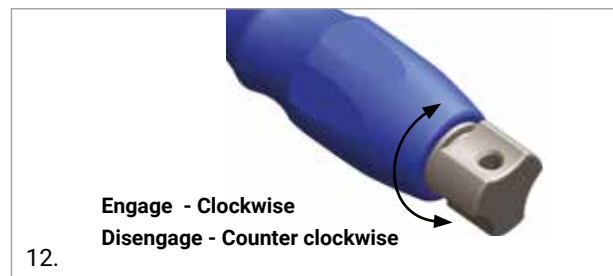

Insert the Trial to determine the appropriate size. Light tapping from the Slotted Mallet may be necessary.



If the Trial is too loose, remove it carefully and select the next higher size. The Trial should be a tight fit and slightly distract the disc space.

**NOTICE:** After impacting the Straight Inserter, it may be necessary to retighten the wheel at the end of the handle.

**NOTICE:** Use the Slotted Mallet or Slap-Hammer to remove the Straight Inserter if necessary.

**NOTICE:** Use X-ray to verify the position of the Trial, the restoration of the disc and the foraminal height. Also check the overall alignment of the spine before selecting your final implant choice.

**2.4 IMPLANT SELECTION & ASSEMBLY**

Select the appropriate size cage implant, based on the outcome of the trial measurements. Use the same height, and footprint that is indicated on the Trial Implant (1). Insert the pin of the plate into the center hole of the cage (2). Rotate clockwise till the plate snaps on the cage (3).

**WARNING**

Select only plates and cages of corresponding heights. Avoid to assemble cage-plate of different heights which may lead to implant failure

**NOTICE:** Use the two grooves on the cage as positioning reference before rotating the plate.

**Flush Plate-Assembly**

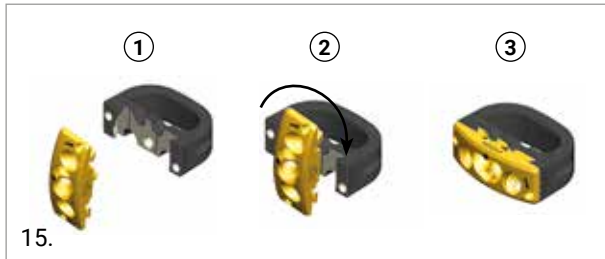

**Long Plate-Assembly**

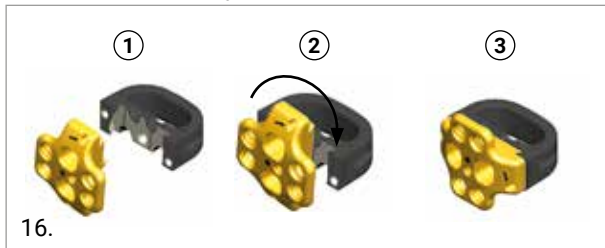

**L5-S1 Plate-Assembly**

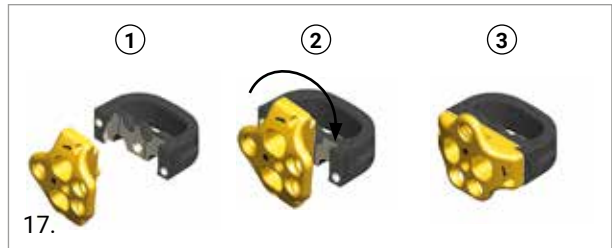

**Hybrid Plate-Assembly**

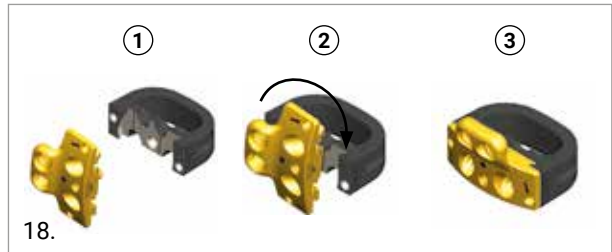

**Simple Plate-Assembly**

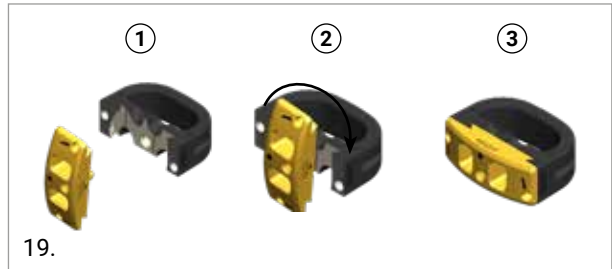

The system is fully locked when the surfaces of the plate and the cage are parallel. This is confirmed when the Straight Inserter pins fit exactly into the cage-plate assembly. Align the black arrow with the black dot of the plate.



If the system needs to be disassembled the Plate Inserter/ Remover can be used to disconnect the plate from the cage.





### 3. IMPLANT INSERTION

#### 3.1 IMPLANT GRAFT PACKING

Autogenous bone graft may be packed in the implant. Firmly pack the graft material in the window of the cage.

To help packing the cage with bone graft, a dedicated Loading Station may be used to place the cage - plate construct.

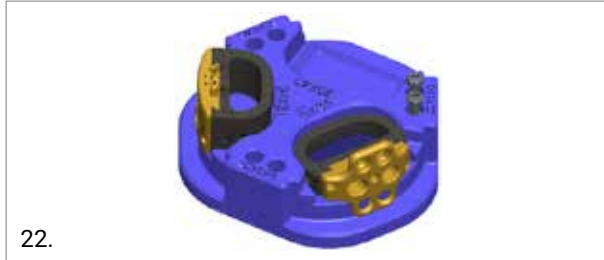

The loading station can also be used to hold the screws while engaging them with the screwdrivers.

#### 3.2 STANDARD IMPLANT PREPARATION & INSERTION

##### “Flush”, “Long”, “L5-S1” and “Hybrid” Plate Implant Preparation & Insertion

While ensuring the correct alignment of the cage to the Straight Inserter, screw the Insert Handle tightly onto the device.

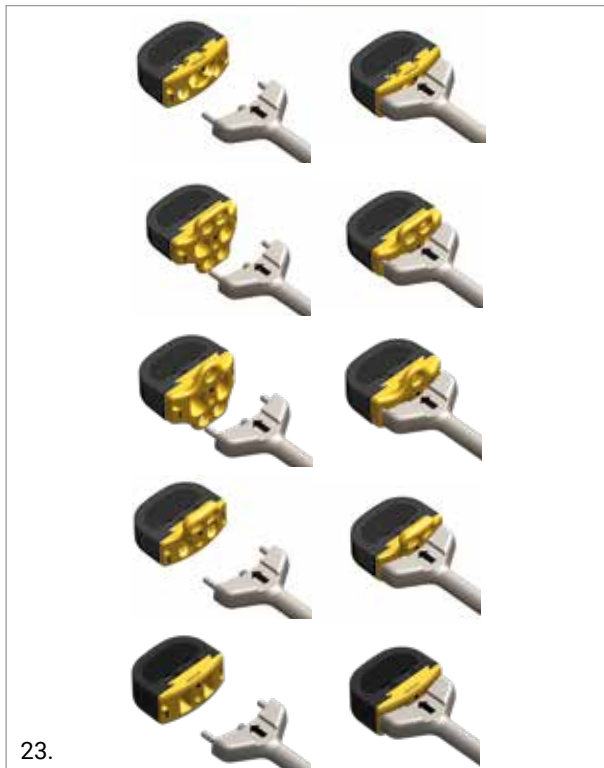

**NOTICE:** The Straight Inserter must be attached firmly to the plate to avoid damage to the implant holder or the plate threads. Ensure the correct device positioning by aligning the arrow on the Straight Inserter with the dot laser marked in the front side of the plate.

Place the implant into the disc space and lightly impact the Straight Inserter with a Slotted Mallet to advance the implant to its desired position.



A Vertebral Distractor can be used to assist with guiding the implant initially to the disc. Hold the Vertebral Distractor firmly.



Slide the implant between the Vertebral Distractor blades and into the disc space until the implant is counter sunk about 3mm beyond the anterior vertebral wall.



Verify the final implant positioning with the aid of an intraoperative lateral & AP X-ray.

Remove the straight Inserter.

**NOTICE:** The Straight Fitting Instrument can be used in case a quick reposition of the implant is necessary after disengagement of the Straight Inserter.

### 3.3 ALTERNATIVE “FLUSH PLATE” IMPLANT PREPARATION & INSERTION

The “Quick Inserter” allows for an alternative technique to insert the flush plate implant configuration. The instruments combines the insertion of the implant with the distraction of the disc space.



**NOTICE:** This instrument can also be used for trial insertion, but not for removal.

Prepare the Quick Inserter by turning the distal blue knob wheel backwards until the pusher is positioned just under the blue handle.

The head of the Quick Inserter has a marked dot. The dot has to be above the upper arrow in order to simplify implant fixation.



Slide the implant between the inserter blades and seat it onto the head. While ensuring the correct alignment of the cage to the head, screw the inner shaft and fix the implant to the Quick Inserter.



The implant inserter must be attached firmly to the plate to avoid damage to the implant holder or the inserter itself.

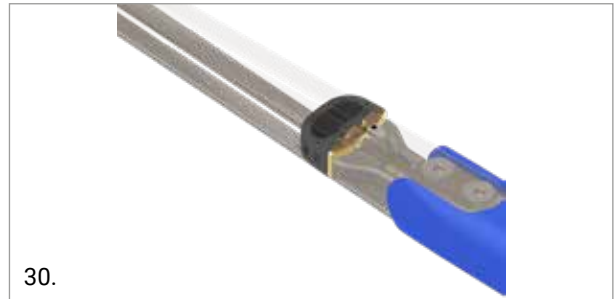

Insert the tips of the inserter's blade into the disc space. The depth stops on the tips should be in contact with the anterior wall of the vertebral body.



By turning the distal blue wheel clockwise you will advance the implant towards the disc space. Tension will increase as the implant enters the disc space and the blades distract the segment.

**NOTICE:** Ensure that an enough axial force is applied on the inserter in case the blades start to move out the disc space before the implant has reached the final position.



Continue turning the distal blue wheel until the implant is properly seated in the disc space and the ramps are fully ejected and released.



### CAUTION

Take care to retract all soft tissue and blood vessels from the site where the ejection mechanism touches the vertebral body.

### CAUTION

The Quick Inserter is not intended to be used for intervertebral disc height distraction. Doing so could compromise the integrity of the devices utilized. If distraction is necessary, apply the dedicated instrumentation prior to implant insertion.

After verifying proper implant placement proceed with screw placement as described in chapter 4.1 or in the paragraph 5 Guided Technique.

## 4. SCREW INSERTION

### 4.1 FREE HAND TECHNIQUE

#### “Flush”, “Long”, “L5-S1” and “Hybrid” Screw Insertion

Use the Awl Straight/Awl Universal Joint to perforate the cortical bone.



Use the Drill Straight / Drill Universal Joint to set the screw hole length. Couple the Drill Straight with the related sleeve. Push the button to adjust the depth of perforation; the scale reported on the instrument (20-35mm span) corresponds with the related size of the screw to insert.

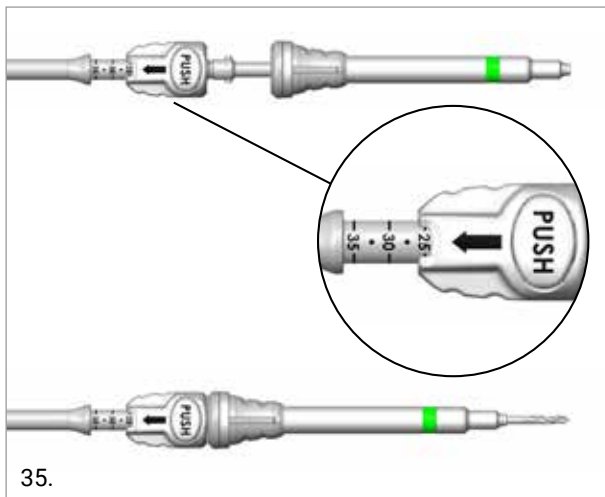

### WARNING

When using the Awl/Drill Universal Joint instruments do not over-angle the distal tip to avoid mechanical blockage. Also avoid non-axial overpressure that may cause tip damage/breakage.

Before inserting the screw, tapping is recommended. Both straight and U-Joint instruments are available.

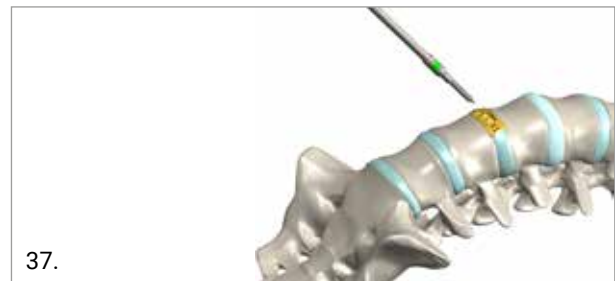

### WARNING

The Tap Straight tip is 30 mm long. When using screws with length < 30 mm, the Tap Straight should not be used all the way through the holes of the plate in order to avoid overlapping.

Connect the screw to the universal joint screwdriver or the straight screwdriver or the angled self-retaining screwdriver.

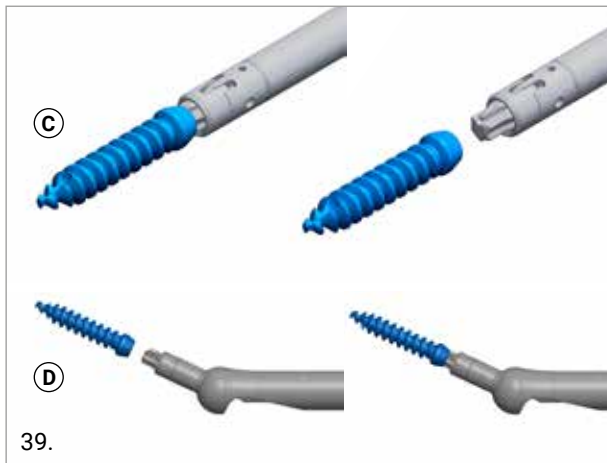
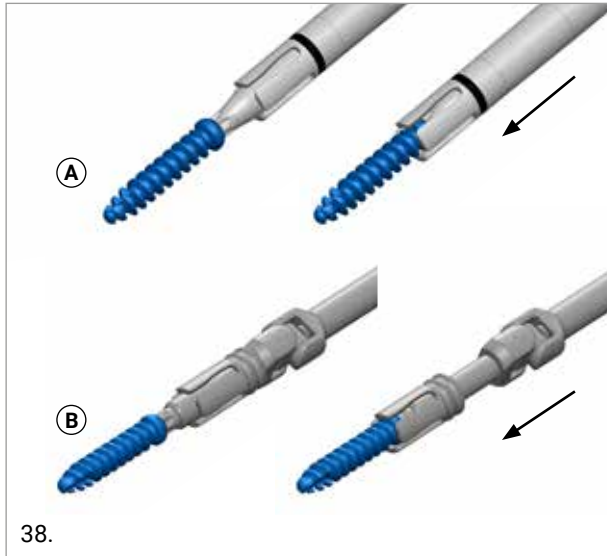

**CAUTION**

The Self-Retaining Straight and Angled Screwdriver (Fig 37 C and D respectively) can be coupled with the Long-Head Screw only. Before connecting the Screw the Screwdrivers must be assembled (Fig. 41).

Insert the screw into the threaded hole of the plate.



Perform the final tightening with the Straight, the Modular or the Angled torque limiter Screwdriver.

All these instruments are equivalent; the surgeon may choose the option that results more ergonomic depending on individual preferences and patient anatomy.

The pictures below show the Modular Straight solution.

**WARNING**

Do not apply lateral bending to avoid breakage or bending.

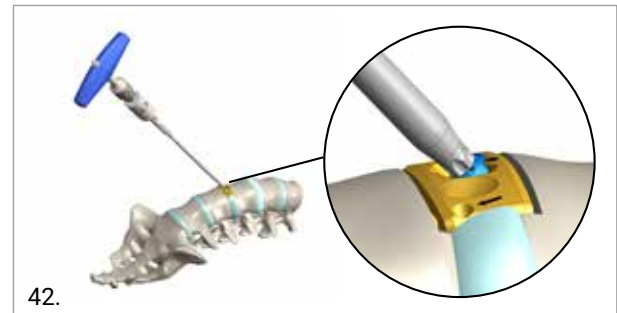
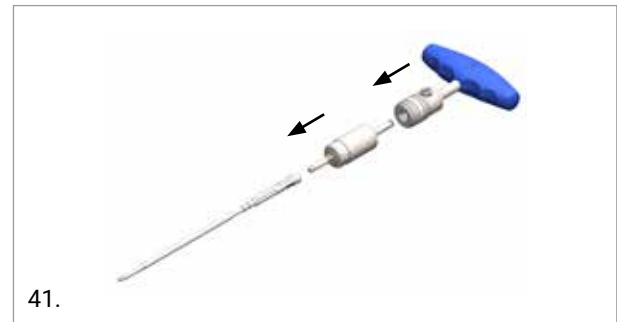

The modular torque limiter must be assembled with the Self-Retaining Screwdriver as shown in the following picture. Insert the inner shaft into the outer shaft and connect to 5.5Nm module. Then connect the T-handle.

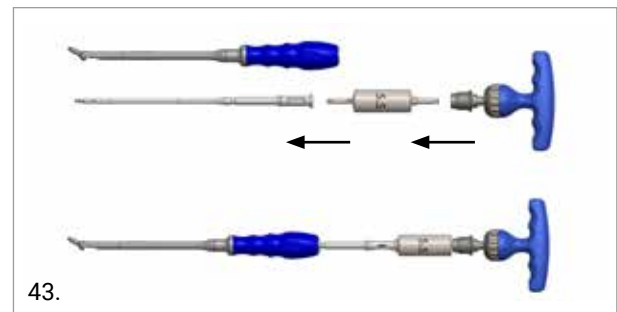

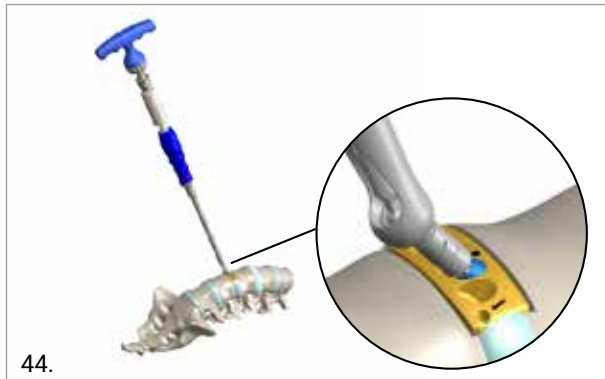

44.

Before cleaning the Screwdriver must be disassembled. Extract the inner shaft from the outer shaft as shown in the following pictures.

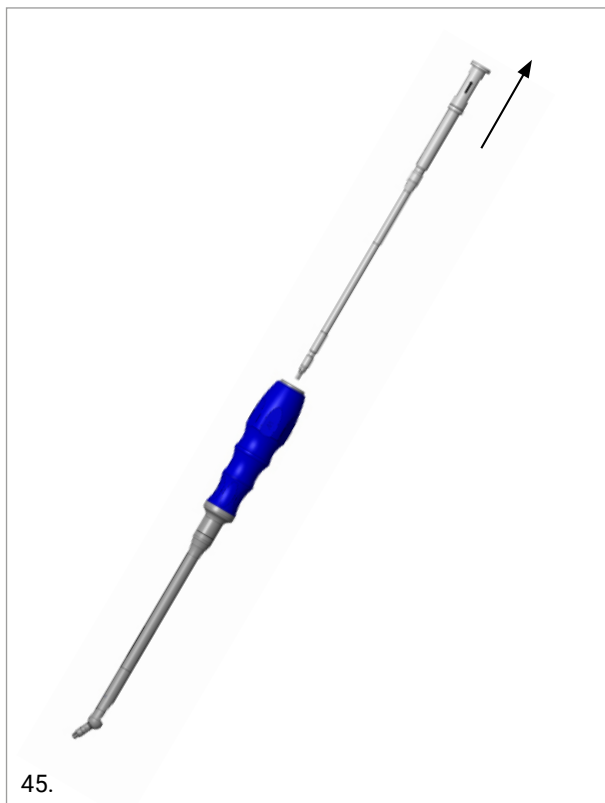

45.

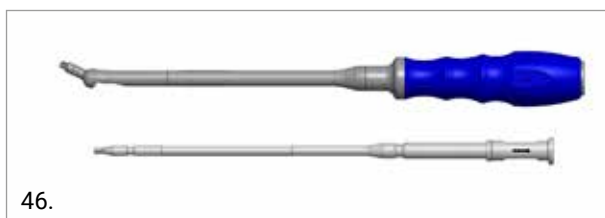

46.

**WARNING**

The 5.5 Nm Torque Limiting Screw Driver must be used to guarantee the correct screw final tightening without damaging screw/instrument interface.

**WARNING**

It is recommended not to use the T-handle with Awls, Taps, Drills and Screwdrivers except for the torque limiting drivers.

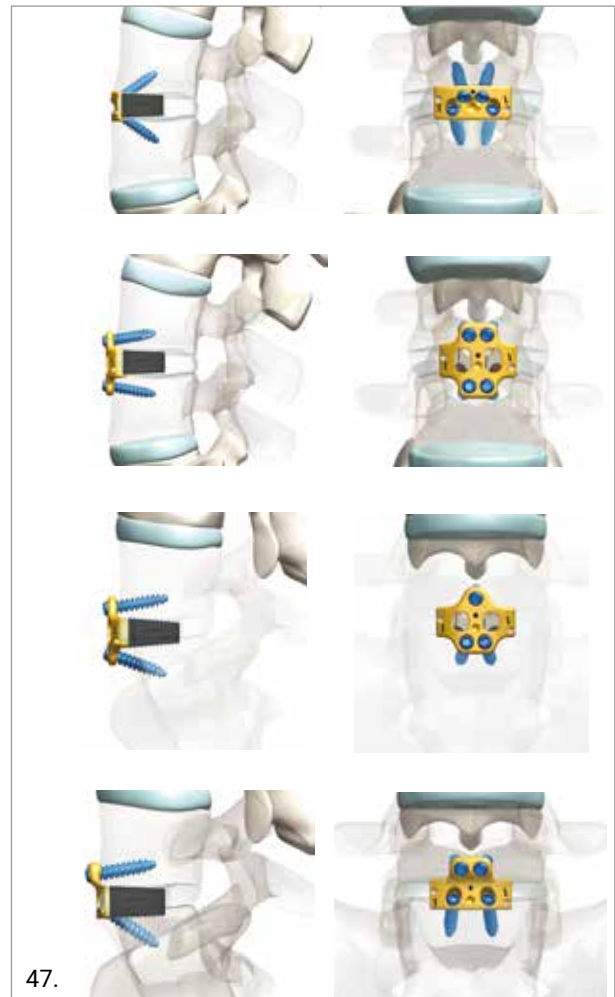

47.

After the insertion of the screws, verify correct placement with the help of an intraoperative AP and lateral X-ray.

**WARNING**

For implantation at two consecutive levels in combination with screws longer than 25mm, the screw length has to be verified by fluoroscopy prior to screw insertion; this is meant to prevent screws interference.

## 5. FLUSH CONSTRUCT - GUIDED TECHNIQUE

Prepare the Flush construct as per the instructed steps in chapter 2.

Assemble the Aiming Device to the Flush construct and then firmly attach it to the Flush construct, by securing the anti back-out mechanism with the Screwdriver Straight.

**NOTICE:** Align the arrow in the Aiming Device with the black dot on the plate.

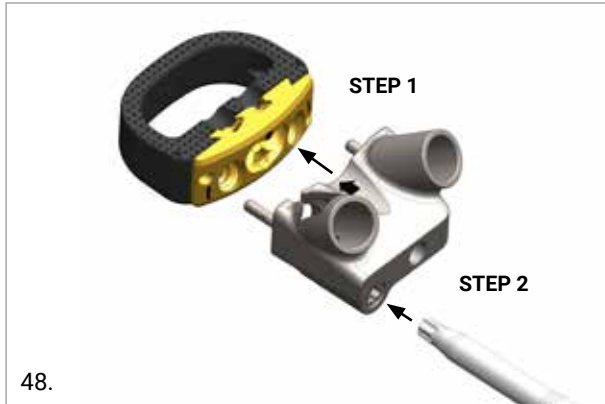

### CAUTION

Do not overtighten the anti back-out mechanism to avoid damages.

Load the dedicated Aiming Device Shaft with a clockwise rotation.



During step 3, rotate the shaft on the Aiming device until its mechanical stop.

Slide the construct into the disc space. The shaft can be then removed for better visibility or left attached to the Aiming device for better handling.



### OPTION

The Flush construct can be alternatively positioned using the standard inserter, the Aiming Device can be then attached in situ.

Insert the Awl Straight/ Awl Universal Joint into the Aiming Device and perforate the cortical bone.

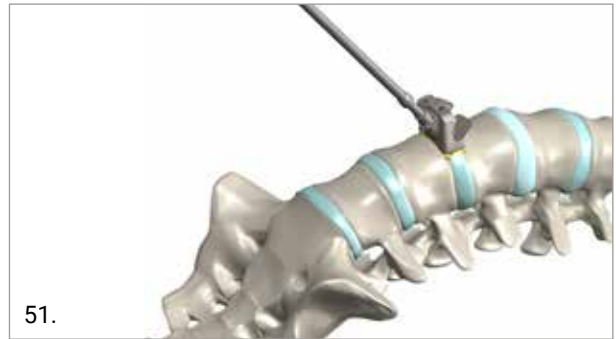

Use the Drill Straight / Drill Universal Joint and drill the bone.

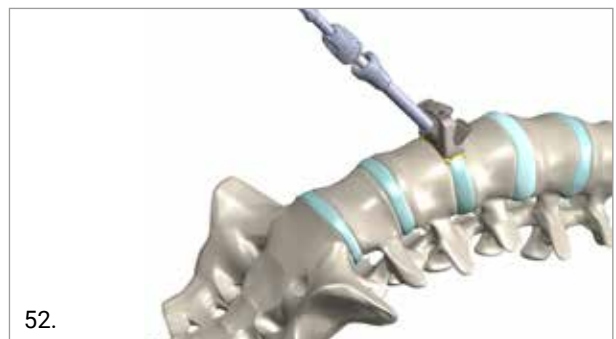

**NOTICE:** The mechanical stop is reached when the green mark is fully inside the aiming device.

Tap the drilled hole. The tap straight is marked at 25mm and 30mm.



**NOTICE:** When the mechanical stop is reached the green marker of the tap is flush with the hole of the Aiming device

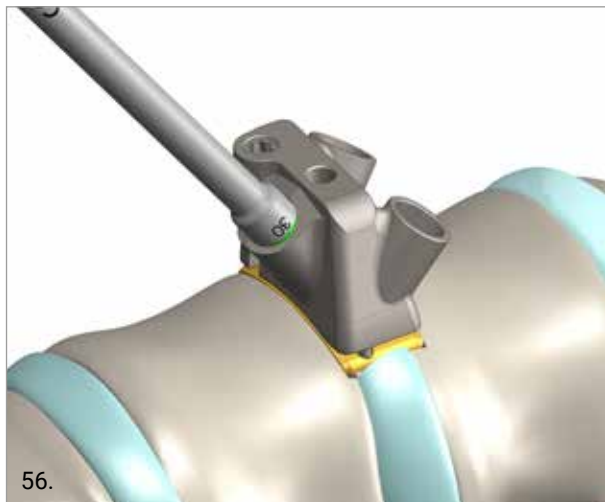
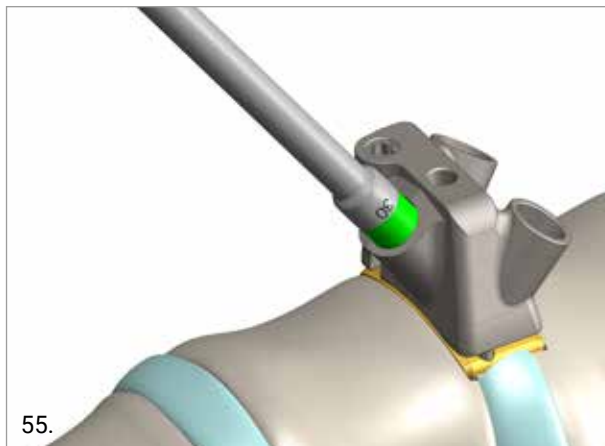
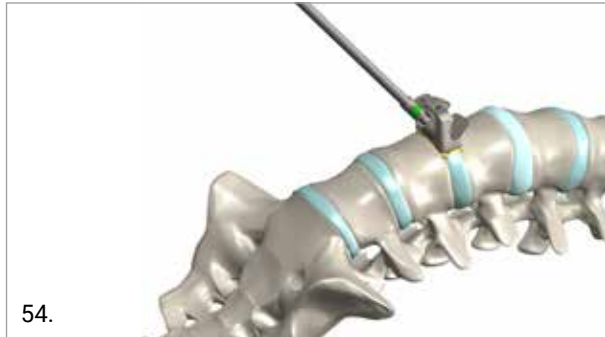

If 25mm Screws/Implants are used stop tapping at the beginning of the green mark. Insert the screw with the Straight/U-joint screwdriver.

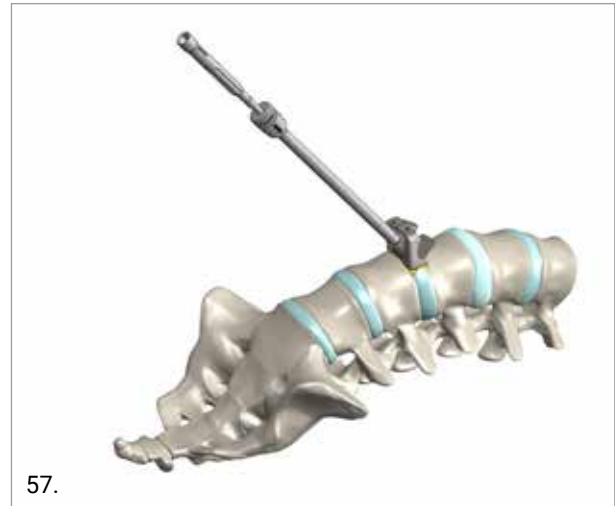

Perform the final tightening at 5.5Nm with the straight or the modular torque limiter .

When using the Targeting Device with the height of 12 or 14mm the Right/Left Perforation through the single hole access located in the caudal side, as well as when using the Targeting Device with the height of 16 or 18mm, must be performed with the dedicated instrument correctly aligned in the counter Right/Left direction (see figure below).



## 6. IMPLANT REMOVAL

If a revision of an implant is performed or a badly-positioned implant needs to be removed, implants can be safely removed using the standard instruments and the Slotted Mallet or Slap Hammer. While ensuring the correct alignment of the cage to the appropriate Implant Inserter, screw the Insert Handle tightly onto the implant. The Implant Handle must be attached firmly to the plate to avoid damage to the Inserter (Implant holder) or the plate threads. Connect the Slotted Mallet or Slap Hammer onto the distal end of the inserter and gently slap back the implant from the disc space.

**NOTICE:** In revision cases bony in-growth on the central threaded hole and screw heads may block proper connection of the instruments. Removal of this bony in-growth is mandatory for safe removal of the implant.



## 7. IMPLANTS NOMENCLATURE

### MECTALIF ANTERIOR TIPEEK CAGES

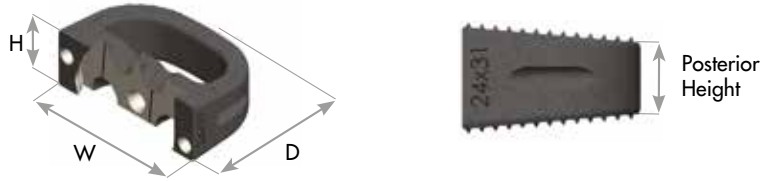

REFERENCE	SIZE (MM) [D X W X H]	LORDOSIS	POSTERIOR HEIGHT (MM)
03.31.001	24x31x10	5°	7.5
03.31.002	24x31x12	5°	9.5
03.31.003	24x31x14	5°	11.5
03.31.004	24x31x16	5°	13.5
03.31.005	24x31x18	5°	15.5
03.31.006	24x31x10	10°	5.8
03.31.007	24x31x12	10°	7.8
03.31.008	24x31x14	10°	9.8
03.31.009	24x31x16	10°	11.8
03.31.010	24x31x18	10°	13.8
03.31.011	24x31x10	15°	4.0
03.31.012	24x31x12	15°	6.0
03.31.013	24x31x14	15°	8.0
03.31.014	24x31x16	15°	10.0
03.31.015	24x31x18	15°	12.0
03.31.031	24x31x 12	20°	4.1
03.31.032	24x31x14	20°	6.1
03.31.033	24x31x16	20°	8.1
03.31.034	24x31x18	20°	10.1
03.31.016	27x35x10	5°	7.2
03.31.017	27x35x12	5°	9.2
03.31.018	27x35x14	5°	11.2
03.31.019	27x35x16	5°	13.2
03.31.020	27x35x18	5°	15.2
03.31.021	27x35x10	10°	5.2
03.31.022	27x35x12	10°	7.2
03.31.023	27x35x14	10°	9.2
03.31.024	27x35x16	10°	11.2
03.31.025	27x35x18	10°	13.2
03.31.026	27x35x10	15°	3.2
03.31.027	27x35x12	15°	5.2
03.31.028	27x35x14	15°	7.2
03.31.029	27x35x16	15°	9.2
03.31.030	27x35x18	15°	11.2
03.31.040	27x35x14	20°	5.0
03.31.041	27x35x16	20°	7.0
03.31.042	27x35x18	20°	9.0

**MECTALIF ANTERIOR TIPEEK CAGES**

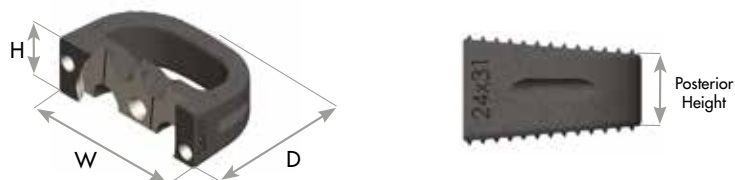

REFERENCE	SIZE (MM) [D X W X H]	LORDOSIS	POSTERIOR HEIGHT (MM)
03.31.060	30 x 40 x 10	5°	7.0
03.31.061	30 x 40 x 12	5°	9.0
03.31.062	30 x 40 x 14	5°	11.0
03.31.063	30 x 40 x 16	5°	13.0
03.31.064	30 x 40 x 18	5°	15.0
03.31.065	30 x 40 x 10	10°	4.7
03.31.066	30 x 40 x 12	10°	6.7
03.31.067	30 x 40 x 14	10°	8.7
03.31.068	30 x 40 x 16	10°	10.7
03.31.069	30 x 40 x 18	10°	12.7
03.31.070	30 x 40 x 12	15°	4.4
03.31.071	30 x 40 x 14	15°	6.4
03.31.072	30 x 40 x 16	15°	8.4
03.31.073	30 x 40 x 18	15°	10.4
03.31.074	30 x 40 x 14	20°	3.9
03.31.075	30 x 40 x 16	20°	5.9
03.31.076	30 x 40 x 18	20°	7.9

### MECTALIF ANTERIOR FLUSH PLATES



REFERENCE	SIZE
03.30.201	Flush Profile H. 12 mm
03.30.202	Flush Profile H. 14 mm
03.30.203	Flush Profile H. 16 mm
03.30.204	Flush Profile H. 18 mm

### MECTALIF ANTERIOR L5-S1 PLATES



REFERENCE	SIZE
03.30.221	L5-S1 Profile H. 10 mm
03.30.222	L5-S1 Profile H. 12 mm
03.30.223	L5-S1 Profile H. 14 mm
03.30.224	L5-S1 Profile H. 16 mm
03.30.225	L5-S1 Profile H. 18 mm

### MECTALIF ANTERIOR LONG PLATES



REFERENCE	SIZE
03.30.211	Long Profile H. 10 mm
03.30.212	Long Profile H. 12 mm
03.30.213	Long Profile H. 14 mm
03.30.214	Long Profile H. 16 mm
03.30.215	Long Profile H. 18 mm

### MECTALIF ANTERIOR HYBRID PLATES



REFERENCE	SIZE
03.30.232	Hybrid Profile H.12 mm
03.30.233	Hybrid Profile H.14 mm
03.30.234	Hybrid Profile H.16 mm
03.30.235	Hybrid Profile H.18 mm

### MECTALIF ANTERIOR SIMPLE PLATES



REFERENCE	SIZE
03.30.251	Simple Profile H.10 mm
03.30.252	Simple Profile H.12 mm
03.30.253	Simple Profile H.14 mm
03.30.254	Simple Profile H.16 mm
03.30.255	Simple Profile H.18 mm

**MECTALIF ANTERIOR SCREWS PRIMARY**



ENHANCED SCREW	SIZE
03.30.111	Screw Ø5 x 25mm (1x)
03.30.112	Screw Ø5 x 30mm (1x)
03.30.113	Screw Ø5 x 35mm (1x)
03.30.114	Screw Ø5 x 40mm (1x)
03.30.131	Screw Ø5 x 25mm (2x)
03.30.132	Screw Ø5 x 30mm (2x)
03.30.133	Screw Ø5 x 35mm (2x)
03.30.134	Screw Ø5 x 40mm (2x)

**MECTALIF ANTERIOR SCREWS REVISION**



ENHANCED SCREW	SIZE
03.30.115	Screw Ø5,5 x 25mm (1x)
03.30.116	Screw Ø5,5 x 30mm (1x)
03.30.117	Screw Ø5,5 x 35mm (1x)
03.30.118	Screw Ø5,5 x 40mm (1x)
03.30.135	Screw Ø5,5 x 25mm (2x)
03.30.136	Screw Ø5,5 x 30mm (2x)
03.30.137	Screw Ø5,5 x 35mm (2x)
03.30.138	Screw Ø5,5 x 40mm (2x)

**MECTALIF ANTERIOR LONG HEAD SCREWS PRIMARY**



ENHANCED SCREW	SIZE
03.30.145	MectaLIF Ant. - Screw Long Head Dia. 5x25 (1x)
03.30.146	MectaLIF Ant. - Screw Long Head Dia. 5x30 (1x)
03.30.147	MectaLIF Ant. - Screw Long Head Dia. 5x35 (1x)
03.30.148*	MectaLIF Ant. - Screw Long Head Dia. 5x40 (1x)
03.30.155	MectaLIF Ant. - Screw Long Head Dia. 5x25 (2x)
03.30.156	MectaLIF Ant. - Screw Long Head Dia. 5x30 (2x)
03.30.157	MectaLIF Ant. - Screw Long Head Dia. 5x35 (2x)
03.30.158*	MectaLIF Ant. - Screw Long Head Dia. 5x40 (2x)

\*On demand

**MECTALIF ANTERIOR LONG HEAD SCREWS REVISION**



ENHANCED SCREW	SIZE
03.30.141	MectaLIF Ant. - Screw Long Head Dia. 5.5x25 (1x)
03.30.142	MectaLIF Ant. - Screw Long Head Dia. 5.5x30 (1x)
03.30.143	MectaLIF Ant. - Screw Long Head Dia. 5.5x35 (1x)
03.30.144*	MectaLIF Ant. - Screw Long Head Dia. 5.5x40 (1x)
03.30.151	MectaLIF Ant. - Screw Long Head Dia. 5.5x25 (2x)
03.30.152	MectaLIF Ant. - Screw Long Head Dia. 5.5x30 (2x)
03.30.153	MectaLIF Ant. - Screw Long Head Dia. 5.5x35 (2x)
03.30.154*	MectaLIF Ant. - Screw Long Head Dia. 5.5x40 (2x)

Part numbers subject to change.

## **NOTE FOR STERILIZATION**

The instruments are not sterile upon delivery. Instruments must be cleaned before use and sterilized in an autoclave respecting the US regulations, directives where applicable, and following the manufactures instructions for use of the autoclave. For detailed instructions please refer to the document "Recommendations for cleaning decontamination and sterilization of Medacta® International reusable orthopaedic devices" available at [www.medacta.com](http://www.medacta.com).



---

**REDEFINING BETTER  
IN ORTHOPAEDICS  
AND SPINE SURGERY**

---

MEDACTA.COM



**Medacta International SA**  
Strada Regina - 6874 Castel San Pietro - Switzerland  
Phone +41 91 696 60 60 - Fax +41 91 696 60 66  
info@medacta.ch

Find your local dealer at: [medacta.com/locations](https://www.medacta.com/locations)

All trademarks and registered trademarks are the property of their respective owners.  
This document is intended for the US market.

MectaLIF Anterior  
Surgical Technique

ref: 99.44AS.12US  
rev. 09

Last update: November 2019