

# **MedactaLIF** OBLIQUE & POSTERIOR

LUMBAR INTERBODY FUSION DEVICE

INTERVERTEBRAL BODY FUSION DEVICE



## Surgical Technique

Joint

**Spine**

Sports Med



## INDEX

<b>1. INTRODUCTION</b>	<b>4</b>
1.1 Materials & Markers	5
<b>2. INDICATIONS</b>	<b>6</b>
<b>3. CONTRAINDICATIONS</b>	<b>6</b>
<b>4. PRE-OPERATIVE PLANNING</b>	<b>6</b>
<b>5. SURGICAL TECHNIQUE POSTERIOR - PLIF</b>	<b>7</b>
5.1 Exposure and Preparation - PLIF	7
5.2 Trial Insertion - PLIF	8
5.3 Implant Placement - PLIF	9
5.4 Radiographic Positioning - PLIF	10
<b>6. SURGICAL TECHNIQUE OBLIQUE - OBLIQUE</b>	<b>11</b>
6.1 Exposure and Preparation - OBLIQUE	11
6.2 Trial Insertion - OBLIQUE	12
6.3 Implant Placement - OBLIQUE	12
6.4 Radiographic Positioning - OBLIQUE	13
<b>7. REMOVAL OF AN INCORRECTLY PLACED IMPLANT</b>	<b>14</b>
<b>8. IMPLANT NOMENCLATURE</b>	<b>15</b>
<b>9. RECOMMENDED FIXATION OPTIONS</b>	<b>24</b>

**1. INTRODUCTION**

The anatomical design of our MectaLIF Intervertebral Body Fusion Device matches the given biological conditions in each patient and pathology and meets the requirements of the treating surgeon.

The PLIF procedure, popularized in the 1950's and 1960's by Cloward, who inserted iliac crest bone into the intervertebral disc space, lost popularity because of the complication rate and technical difficulties. In the 1980's spacers made of titanium or carbon fiber reinforced PEEK were designed to overcome these challenges. However, bone from the iliac crest can be adjusted to the patient's anatomy, compared to metal spacers which are available in a predetermined design.

These thoughts led us to the development of our MectaLIF Posterior and MectaLIF Oblique Intervertebral Body Fusion Device, whose anatomical design features offer distinctive benefits.

- Uniform, easy instrumentation for unilateral transforaminal/oblique approach (TLIF) or a bilateral posterior approach (PLIF)
- Biconvex superior/inferior surface that closely match the native anatomy

- Different footprints (three) and heights (nine) are offered to address individual patient anatomy
- The footprint as well as the outer counter is anatomically shaped to facilitate optimal load transfer and maximize the implant-endplate contact surface
- Large central as well as lateral window to receive filling material (bone graft or substitute) to accelerate the occurrence of fusion through the implant
- Pyramid shaped teeth to enhance both the implant stability and the resistance to implant migration
- Shapes ranging from parallel to lordotic to restore natural sagittal alignment
- Self-distracting bullet nose tip for simplicity of insertion
- Available in two versions: PEEK, TiPEEK
- PEEK is radiolucent and optimizes the load transfer between the cage and the adjacent vertebral bodies and reduces the effects of stress shielding on the graft material.
- TiPEEK, is a titanium coated PEEK cage that combines the features from PEEK with the osteo-conductive features of titanium.

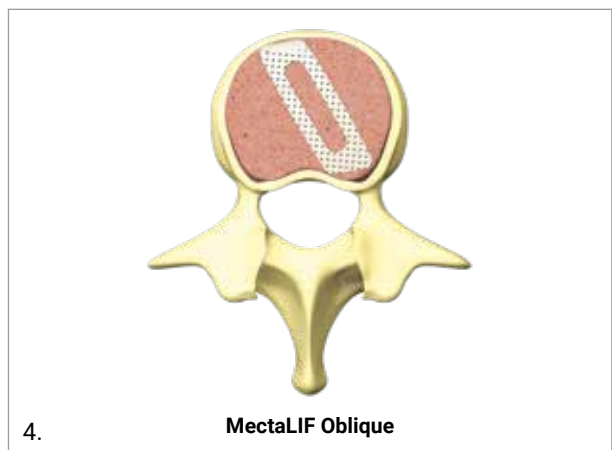
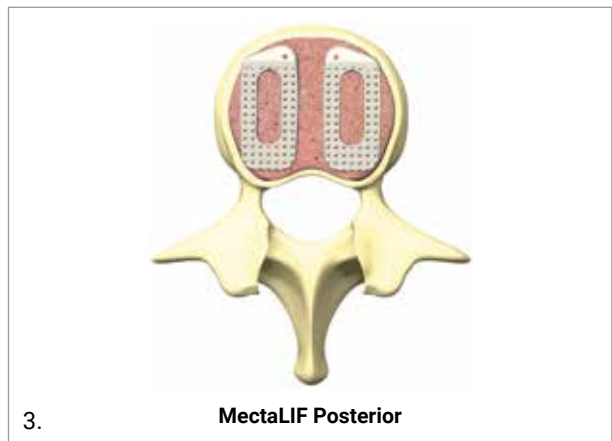

### 1.1 MATERIALS & MARKERS

- Biocompatible radiolucent PEEK with a favorable modulus of elasticity allows a clear assessment of bony fusion
- Posterior and anterior marker pins (Tantalum or Titanium) allow a easy and clear visualization.

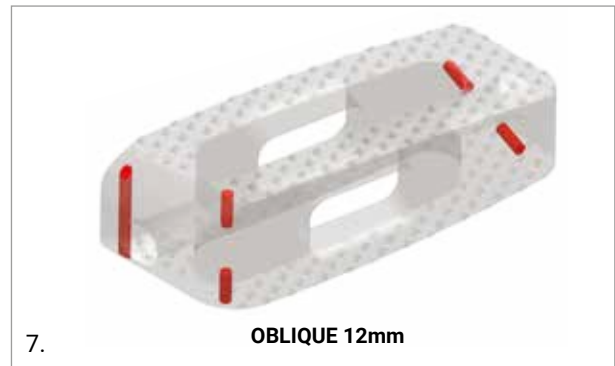
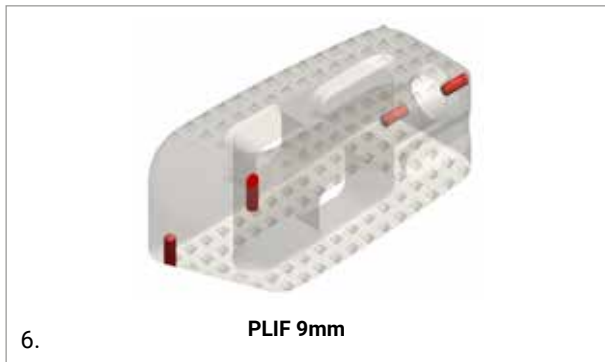
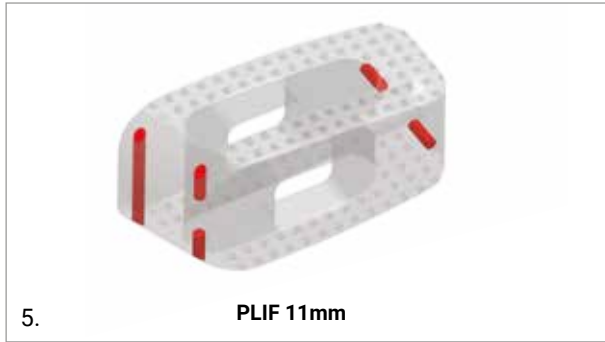

Ventral/Dorsal Approach MectaLIF Oblique

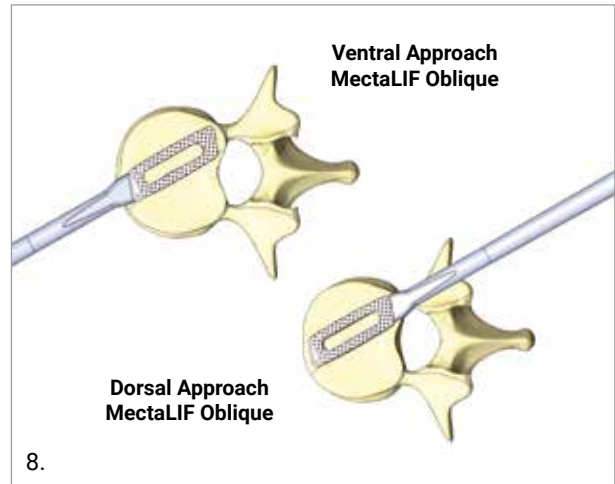

## 2. INDICATIONS

The MectaLIF implants in combination with supplemental fixation are indicated for use with autogenous bone graft in patients with degenerative disc disease (DDD) at one or two contiguous spinal levels from L2 – S1 whose condition requires the use of interbody fusion. Degenerative disc disease is defined as discogenic pain with degeneration of

the disc confirmed by patient history and radiographic studies. These patients may have had a previous non-fusion spinal surgery at the involved spinal level(s). Patients must be skeletally mature. Patients should have received 6 months of non-operative treatment prior to treatment with the devices.

## 3. CONTRAINDICATIONS

The MectaLIF Posterior, MectaLIF Oblique Intervertebral Body Fusion Device System in combination with a pedicle screw system should not be implanted in patients with active systemic infection or infection localized to the site of implantation.

Please see the package insert for the full list of indications, contra-indications, precautions and warnings.

## 4. PRE-OPERATIVE PLANNING

Prior to any surgical implantation of the device, it is critical to evaluate the patient's pre-operative MRI and/or CT scan to template and determine the most appropriate size and

type of implant to be used so as to match the patient's anatomy.

## 5. SURGICAL TECHNIQUE POSTERIOR - PLIF

### 5.1 EXPOSURE AND PREPARATION - PLIF

Start the skin incision and dissection laterally from the midline. Locate the spinous process and the lamina of the corresponding level(s).

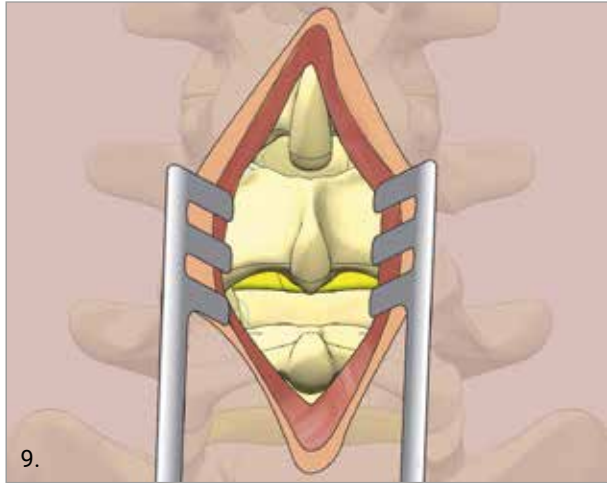

#### CAUTION

Perform a laminotomy sufficiently large enough for the PLIF preparation. Ensure that the neural structures are protected throughout the entire disc space exposure.

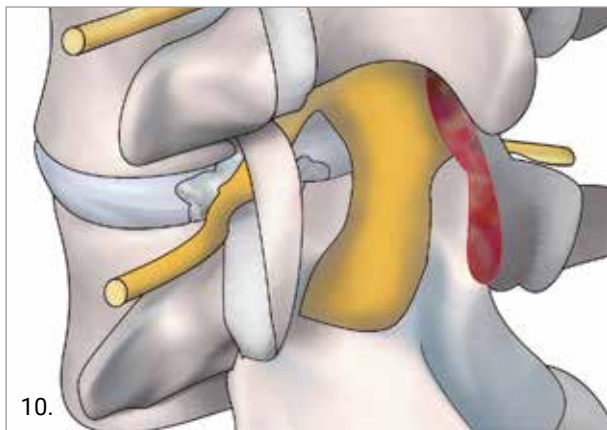

A conventional discectomy is performed by incising the annulus lateral to the dural sac.

Use the curette to remove the disc through the incision window leaving only the anterior and lateral annulus intact.

This is done bilaterally, cosecutively the disc fragments from the intradiscal space are removed with disc rongeurs in standard fashion. The importance of this is to remove extruded fragments, to adequately decompress the neural elements, and to provide entry to the disc space for distraction with minimal or no nerve root retraction. If there is significant disc space collapse, a complete discectomy may not be possible until disc space distraction is accomplished. It is also important to remove osteophytes and posterior lips of the adjacent vertebral body with an osteotome.

The disc space is sequentially distracted until original disc space height is obtained and normal foraminal heights are restored. It is critical to ensure that the segment is not overdistracted.

Depending on the pathology and the surgeon's preference there are two other methods to achieve disc space distraction: either via pedicle screws or using a lamina spreader.

Remaining soft tissue or cartilaginous endplate are removed with vigorous scraping or curettage, which is essential for good vascularization of the bone graft. Excessive endplate preparation, however, can weaken the endplates and predispose to fracture or device subsidence. It is therefore of paramount importance to remove only the cartilaginous portion of the endplates, and to maintain the integrity of the underlying bony endplate which provides compressive resistance.

5.2 TRIAL INSERTION - PLIF

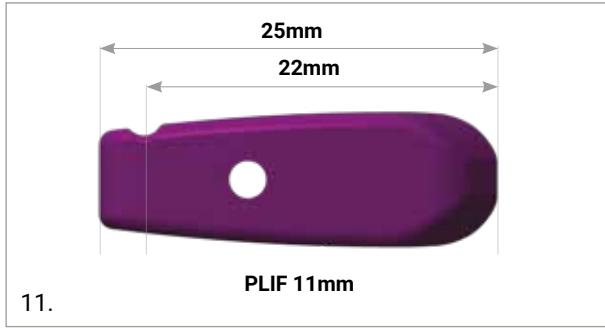

The length of the Trial Implants is 25 mm.

The notch on the top of the trial indicates 22 mm which is equivalent to the shorter version of the cage.

Select the size of the Trial Implant as determined during preoperative planning and confirmed by intraoperative fluoroscopy and attach it to the dedicated inserter. The inserter for PLIF 9mm can be distinguished from the inserter for PLIF 11mm thanks to the two anterior prongs that match with the posterior grooves of the trial and the proximal gear to lock/unlock the trial/implants. Each inserter must be used only with the related trials.

**WARNING**

Markers on the Trials, Inserters and Implants must be aligned to confirm proper engagement of the Trial/Implant with the related inserter. See fig 13 and 14.

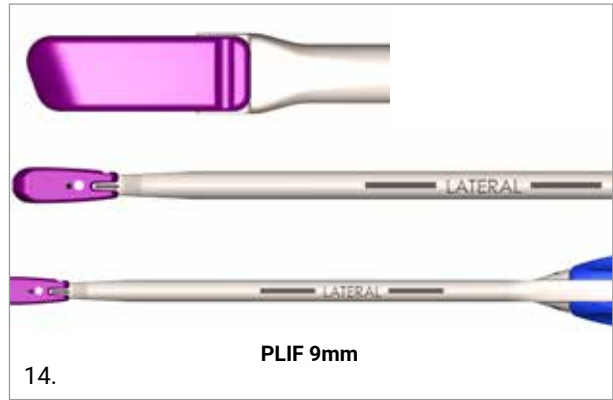
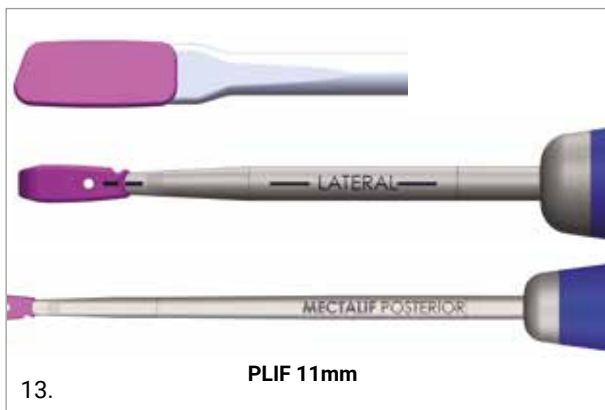

The Inserter to be used is marked "MectaLIF Posterior" on the shaft. The mark "LATERAL" indicates the proper alignment of the instrument in respect to the patient. Insert the Trial Implant into the disc space by light impaction and confirm proper position, depth, and size with intraoperative fluoroscopy and tactile feel.

If the Trial Implant is too loose or too tight, try the next larger/smaller size until a secure fit is achieved. Using the largest possible implant improves stability by creating tension on the ligaments and the annulus fibrosus.

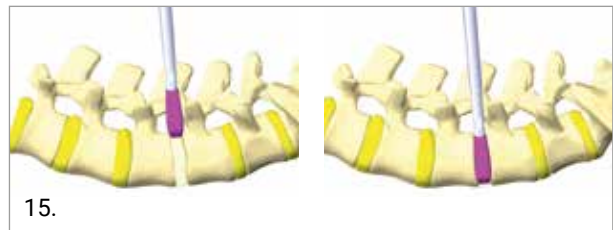

Remove the Trial Implant assembly and select the matching implant. If necessary, the Slap Hammer / Slotted Hammer is available to assist in safe removal of the Trial Implant.



### 5.3 IMPLANT PLACEMENT - PLIF

Prepare autologous bone graft and / or synthetic bone graft substitute mixed with autologous bone graft and / or freshly aspirated bone marrow; place it at the anterior rim of the vertebral body and impact it gently before inserting the implant. Different Bone Graft Impactors as well as a Bone Tamp are included in the instrument set. Gently pack bone graft and /or synthetic bone graft substitute into the opening of the cage using the Filler Block and Bone Tamp.

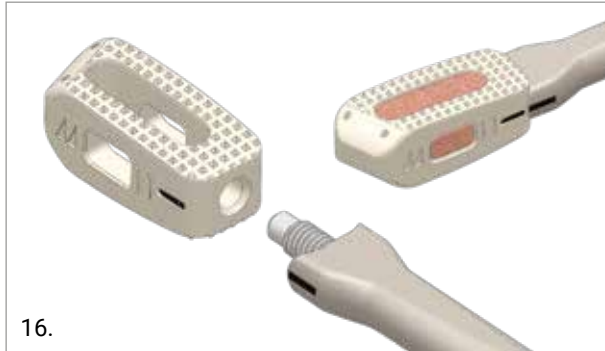

Attach the implant perpendicular to the Inner Rod / Posterior Handle assembly by screwing the thread of the Inner Rod into the threaded hole and secure it firmly. The cylindrical tip of the Inner Rod simplifies the fixation of the implant.

If 9mm PLIF are used, match the prongs of the PLIF 9mm inserter with the implant grooves until the mechanical stop.

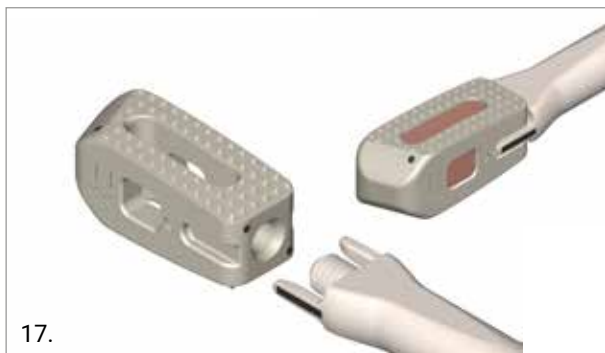

Rotate the proximal gear to lock the implant.

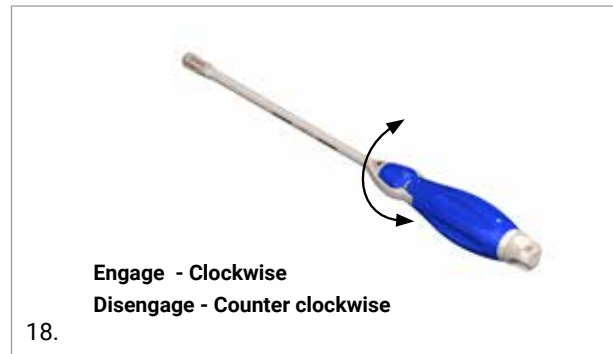

**NOTE:** ensure that the orientation of the implant is correct (see marker line on the implant which should line up with the corresponding line on the instrument).

Insert the implant straight into the intervertebral disc space by gentle impaction.

#### CAUTION

Protect the nerve roots and thecal sac with a suitable instrument.

Check the position of the implant with the image intensifier. Remove the instrument if the implant position is to your satisfaction. Insert the second implant on the contralateral side as described before. If necessary, lightly tap the implant into position using the Cage Impactor and the Slap Hammer / Slotted Hammer.



**5.4 RADIOGRAPHIC POSITIONING - PLIF**

Check the position of the implant with the image intensifier.

Correct Lateral View: the implant should appear as in the figures below.

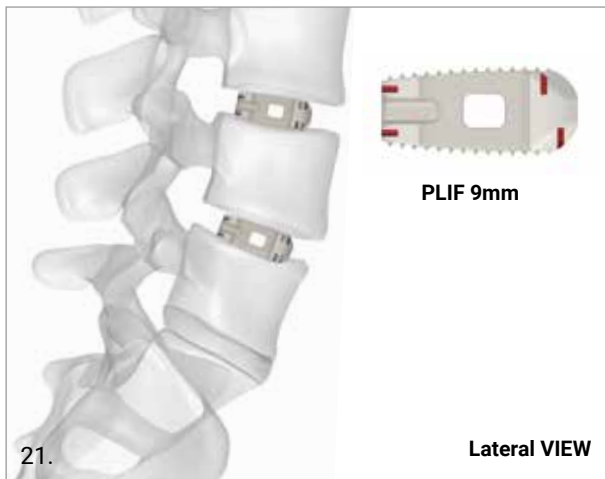
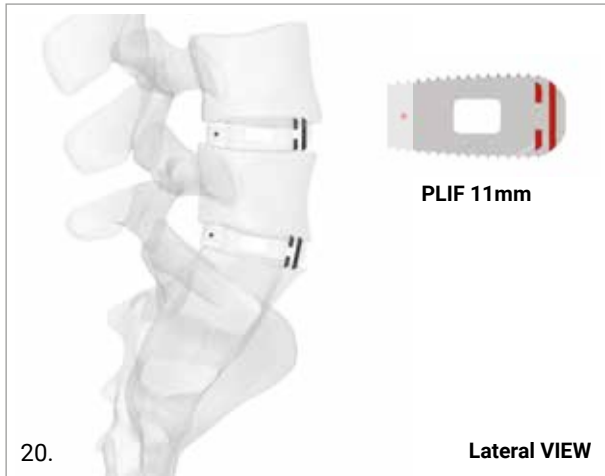

Correct AP View. The implant should appear as in the following figures.

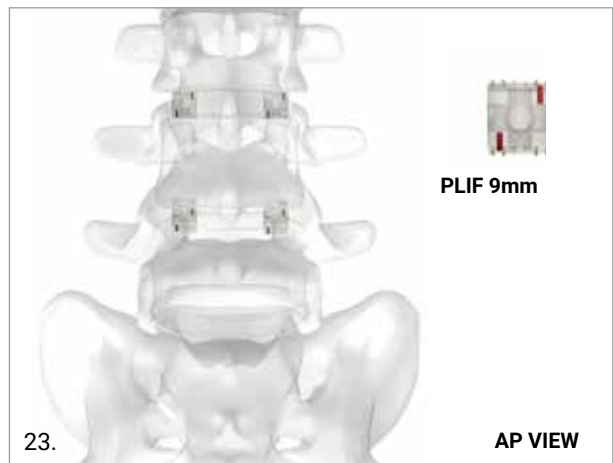
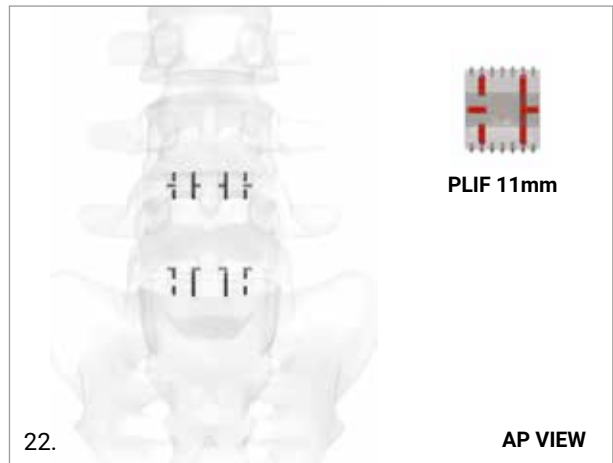

Check the position of the implant with the image intensifier.

Insert the second implant on the contralateral side as described before. If necessary tap lightly the implant into position with the Cage Impactor and the Slap Hammer / Slotted Hammer.

Remove the instrument if the implant is in satisfactory position. Be careful to ensure proper alignment of the implants.

## 6. SURGICAL TECHNIQUE OBLIQUE - OBLIQUE

### 6.1 EXPOSURE AND PREPARATION - OBLIQUE

The OLIF technique can be performed either in open or mini-open approach.

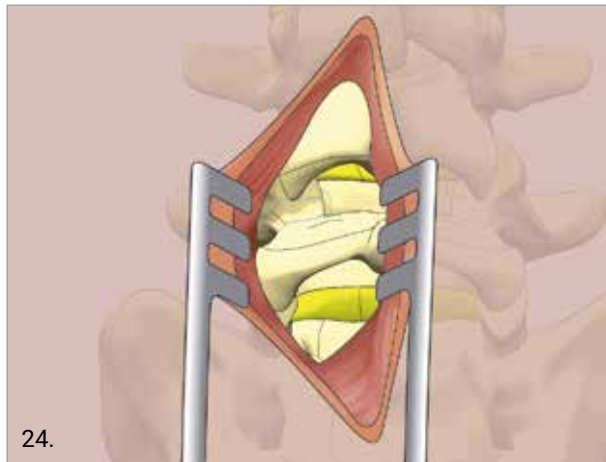

Start the skin incision and dissect laterally from the midline. Locate the spinous process and the lamina of the corresponding layer(s) (A).

Prepare a window for the oblique approach, using an osteotome or drill, to remove the inferior facet of the cranial vertebra and the superior facet of the caudal vertebra (B). Ensure that the neural structures are spared as much as possible. Additional bone removal may be carried out using a Kerrison rongeur or drill.

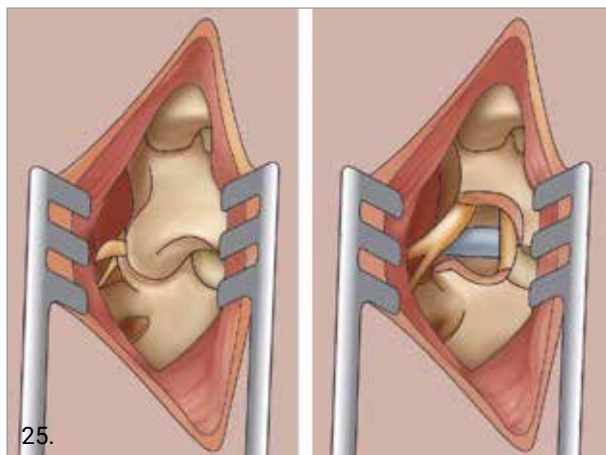

Divide the ligamentum flavum from the inferior portion of the lamina. Expose the nerve root and dural tube from soft

tissue, probe with ball point instrument. Gently retract the nerve root and dural tube. Then create the annular window with an annulus knife.

To assist distraction during disc space preparation, pedicle screws and rod can be inserted on the contralateral side.

Use the curette to remove the disc through the incision window. The annulus must be preserved to provide additional support. A combination of shavers, pituitary rongeurs, and curettes designed for intervertebral discs can facilitate removal of the nucleus pulposus and the surface layers of the cartilaginous endplates.

The critical steps include adequate removal of extruded disc fragments, adequate decompression of the traversing and exiting nerve roots, and to provide entry to the disc space for distraction with minimal or no nerve root retraction. If there is significant disc space collapse, a complete discectomy may not be possible until disc space distraction is accomplished.

#### **WARNING**

Be sure to remove osteophytes and posterior lips of the adjacent vertebral body with an osteotome so as to avoid neural impingement or graft malalignment.

The disc space is sequentially distracted until adequate disc space height is obtained and normal foraminal heights are restored. Insert the shavers with the curved sides touching the endplates. Insert shavers sequentially until the desired height is obtained.

#### **WARNING**

It is critical to ensure that the segment is not overdistracted.

Depending on the pathology and the surgeon's preference there are two other methods to achieve disc space distraction: either via pedicle screws or using a lamina spreader.

Remaining soft tissue or cartilaginous endplate are removed with vigorous scraping or curettage, which is essential for good vascularization of the bone graft.

#### **WARNING**

Excessive endplate preparation, however, can weaken the endplates and predispose to fracture or device subsidence. It is therefore of paramount importance to remove only the cartilaginous portion of the endplates, and to maintain the integrity of the underlying bony endplate which provides compressive resistance.

**6.2 TRIAL INSERTION - OBLIQUE**

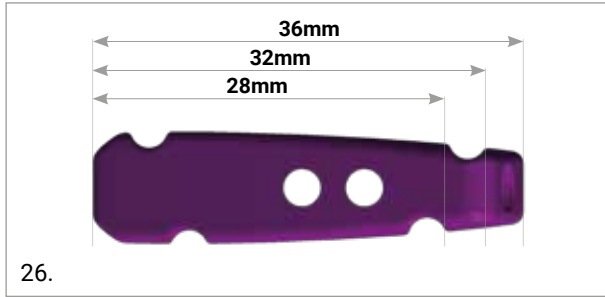

The Trials as well as the implants have A (Anterior) and P (Posterior) markings to facilitate proper orientation. The lengths of the Trials are 36 mm and the two pair of notches on the Trial indicates 32mm and 28mm, respectively. Each pair of notches are on both side to allow ventral or dorsal access.



The mark "MEDIAL" indicates the proper alignment of the instrument in respect to the patient. Visualization of the two holes in the Trial indicate on a true lateral x-ray that the Trial is in the correct position, i.e. 30° in the sagittal plane. The medial mark on the instrument indicates correct alignment.



Select the size of the Trial Implant as determined during preoperative templating and confirmed intraoperatively by fluoroscopy and attach it to the inserter assembly. Insert the Trial Implant into the disc space by light impaction and confirm the proper position with the aid of anterior-posterior and lateral fluoroscopy.

If the Trial Implant is too loose or too tight, try the next larger/smaller size until a secure fit is achieved. Using the largest possible implant improves stability by creating tension on the ligaments and the annulus fibrosus.

Remove the Trial Implant and select the matching implant. If necessary the Slap Hammer/Slotted Hammer is available to assist in safe removal of the Trial Implant.

**6.3 IMPLANT PLACEMENT - OBLIQUE**

Prepare autologous bone graft and/or synthetic bone graft substitute like MectaGel or MectaBone-G mixed with autologous bone graft and/or freshly aspirated bone marrow; place it anteriorly and contralaterally before inserting the implant.

Gently pack bone graft and/or synthetic bone graft substitute into the opening of the selected cage using the filler block and bone tamp.

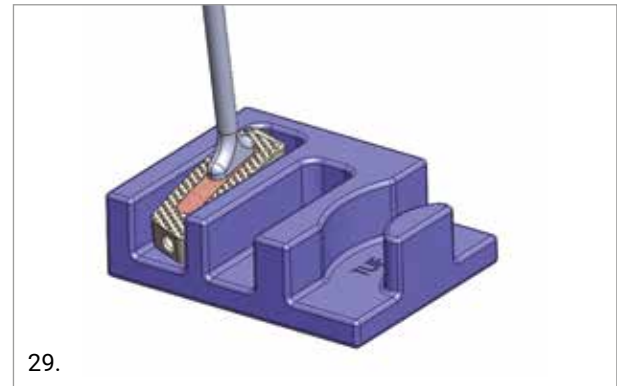

Different shapes of bone graft impactors are available in the set.



Attach the cage perpendicular to the Oblique Handle / Inner Rod assembly by screwing the thread of the Inner Rod into the threaded hole and secure it firmly. Ensure that the orientation of the implant is correct (see illustration). The cylindrical guiding tip on the Inserter simplifies the engaging of the instrument.

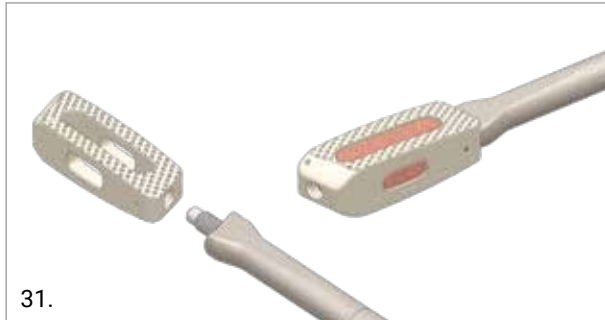

Insert the implant into the intervertebral disc space by gentle impaction.

**NOTE:** check the orientation of the medial marking on the Oblique Handle to confirm the correct positioning of the cage.

### CAUTION

Protect the nerve root with a suitable instrument.

If necessary tap lightly the implant into position with the Oblique Implant Impactor into position with the Cage Impactor and the Slotted Hammer / Slap Hammer.

## 6.4 RADIOGRAPHIC POSITIONING - OBLIQUE

Check the position of the implant with the image intensifier.

Correct Lateral view. The implant should appear as in the image below.

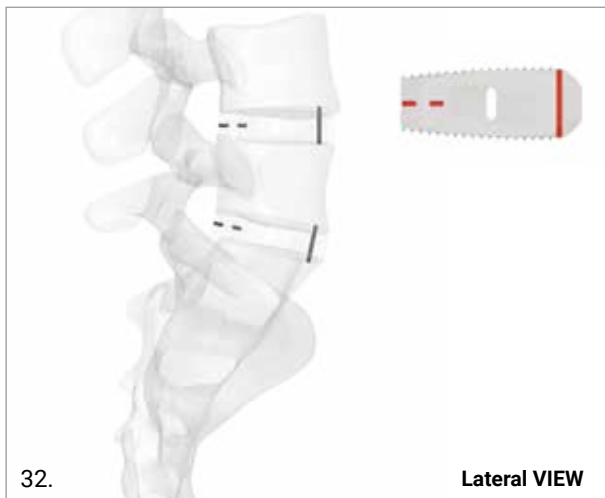

The broken line marker indicates the deviation of the implant position (see below).

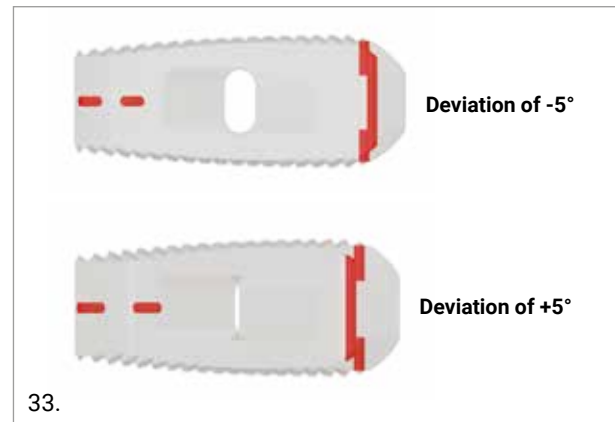

Correct AP view. The implant should appear as in the image below.

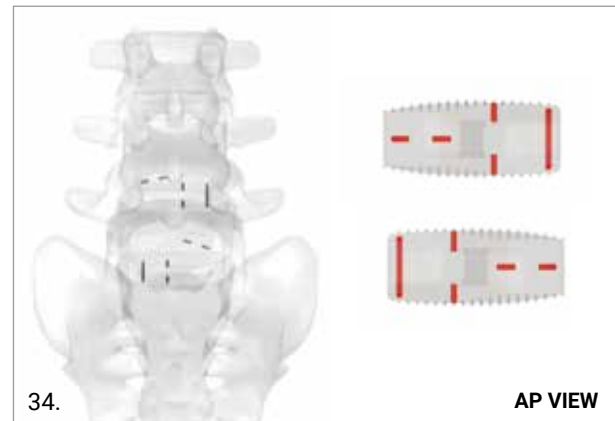

Remove the instrument if the implant is in satisfactory position.

To achieve satisfactory immobilization of the grafted interbody space compression on the additional posterior fixation with a pedicle screw system is recommended.

## 7. REMOVAL OF AN INCORRECTLY PLACED IMPLANT

Attach the Implant Remover or the Oblique Handle/Inner rod assembly perpendicular to the implant and remove the implant from its site. If necessary, the Slap Hammer / Slotted Hammer are available to assist in safe removal of the implant.

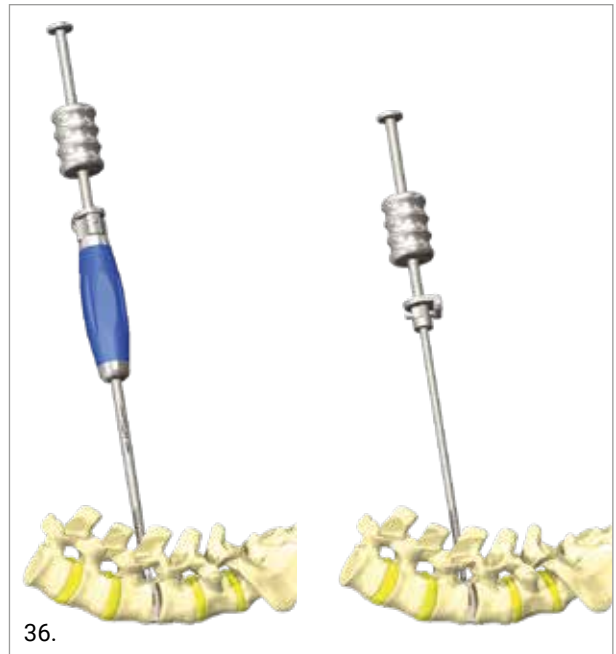
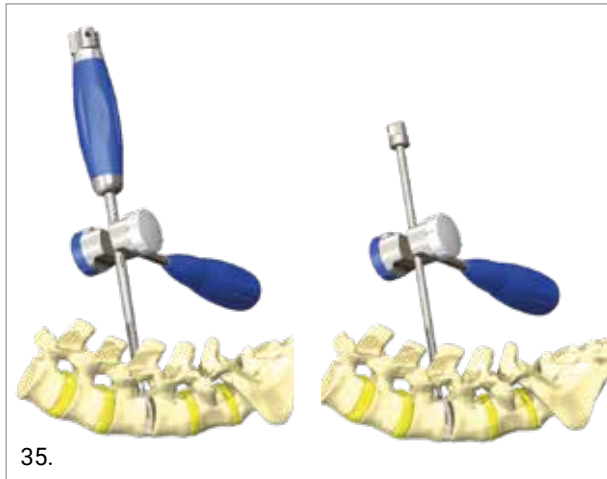

For any further information related to the MectaLIF Intervertebral Body Fusion Devices please refer to the package insert.

The MectaLIF Posterior and the MectaLIF Oblique implants are supplied sterile in single-use packages; they should never be re-used.

## 8. IMPLANT NOMENCLATURE

### MECTALIF POSTERIOR TRIAL 11x22MM



REFERENCE	SIZE(MM) - LORDOSIS(°)	COLOR
03.22.10.0150*	22x7 - 0°	Light Blue
03.22.10.0151*	22x8 - 0°	Dark Brown
03.22.10.0152*	22x9 - 0°	Violet
03.22.10.0153*	22x10 - 0°	Silver
03.22.10.0154*	22x11 - 0°	Gold
03.22.10.0155*	22x12 - 0°	Orange
03.22.10.0156*	22x13 - 0°	Dark Blue
03.22.10.0157*	22x14 - 0°	Pink
03.22.10.0158*	22x15 - 0°	Dark Green
03.22.10.0159*	22x7 - 5°	Light Blue
03.22.10.0160*	22x8 - 5°	Dark Brown
03.22.10.0161*	22x9 - 5°	Violet
03.22.10.0162*	22x10 - 5°	Silver
03.22.10.0163*	22x11 - 5°	Gold
03.22.10.0164*	22x12 - 5°	Orange
03.22.10.0165*	22x13 - 5°	Dark Blue
03.22.10.0166*	22x14 - 5°	Pink
03.22.10.0167*	22x15 - 5°	Dark Green
03.22.10.0168*	22x9 - 10°	Violet
03.22.10.0169*	22x10 - 10°	Silver
03.22.10.0170*	22x11 - 10°	Gold
03.22.10.0171*	22x12 - 10°	Orange
03.22.10.0172*	22x13 - 10°	Dark Blue
03.22.10.0173*	22x14 - 10°	Pink
03.22.10.0174*	22x15 - 10°	Dark Green

### MECTALIF POSTERIOR TRIAL 11x25MM



REFERENCE	SIZE(MM) - LORDOSIS(°)	COLOR
03.22.10.0175*	25x7 - 0°	Light Blue
03.22.10.0176*	25x8 - 0°	Dark Brown
03.22.10.0177*	25x9 - 0°	Violet
03.22.10.0178*	25x10 - 0°	Silver
03.22.10.0179*	25x11 - 0°	Gold
03.22.10.0180*	25x12 - 0°	Orange
03.22.10.0181*	25x13 - 0°	Dark Blue
03.22.10.0182*	25x14 - 0°	Pink
03.22.10.0183*	25x15 - 0°	Dark Green
03.22.10.0184	25x7 - 5°	Light Blue
03.22.10.0185	25x8 - 5°	Dark Brown
03.22.10.0186	25x9 - 5°	Violet
03.22.10.0187	25x10 - 5°	Silver
03.22.10.0188	25x11 - 5°	Gold
03.22.10.0189	25x12 - 5°	Orange
03.22.10.0190	25x13 - 5°	Dark Blue
03.22.10.0191	25x14 - 5°	Pink
03.22.10.0192	25x15 - 5°	Dark Green
03.22.10.0193	25x9 - 10°	Violet
03.22.10.0194	25x10 - 10°	Silver
03.22.10.0195	25x11 - 10°	Gold
03.22.10.0196	25x12 - 10°	Orange
03.22.10.0197	25x13 - 10°	Dark Blue
03.22.10.0198	25x14 - 10°	Pink
03.22.10.0199	25x15 - 10°	Dark Green

\*Special order / request / special forecast



**MECTALIF POSTERIOR TRIAL 9x22MM**



REFERENCE	SIZE(MM) - LORDOSIS(°)	COLOR
03.22.10.0901*	22x7 - 0°	Light Blue
03.22.10.0902*	22x8 - 0°	Dark Brown
03.22.10.0903*	22x9 - 0°	Violet
03.22.10.0904*	22x10 - 0°	Silver
03.22.10.0905*	22x11 - 0°	Gold
03.22.10.0906*	22x12 - 0°	Orange
03.22.10.0907*	22x13 - 0°	Dark Blue
03.22.10.0908*	22x14 - 0°	Pink
03.22.10.0909*	22x15 - 0°	Dark Green
03.22.10.0910*	22x7 - 5°	Light Blue
03.22.10.0911*	22x8 - 5°	Dark Brown
03.22.10.0912*	22x9 - 5°	Violet
03.22.10.0913*	22x10 - 5°	Silver
03.22.10.0914*	22x11 - 5°	Gold
03.22.10.0915*	22x12 - 5°	Orange
03.22.10.0916*	22x13 - 5°	Dark Blue
03.22.10.0917*	22x14 - 5°	Pink
03.22.10.0918*	22x15 - 5°	Dark Green
03.22.10.0919*	22x9 - 10°	Violet
03.22.10.0920*	22x10 - 10°	Silver
03.22.10.0921*	22x11 - 10°	Gold
03.22.10.0922*	22x12 - 10°	Orange
03.22.10.0923*	22x13 - 10°	Dark Blue
03.22.10.0924*	22x14 - 10°	Pink
03.22.10.0925*	22x15 - 10°	Dark Green

**MECTALIF POSTERIOR TRIAL 9x25MM**



REFERENCE	SIZE(MM) - LORDOSIS(°)	COLOR
03.22.10.0926*	25x7 - 0°	Light Blue
03.22.10.0927*	25x8 - 0°	Dark Brown
03.22.10.0928*	25x9 - 0°	Violet
03.22.10.0929*	25x10 - 0°	Silver
03.22.10.0930*	25x11 - 0°	Gold
03.22.10.0931*	25x12 - 0°	Orange
03.22.10.0932*	25x13 - 0°	Dark Blue
03.22.10.0933*	25x14 - 0°	Pink
03.22.10.0934*	25x15 - 0°	Dark Green
03.22.10.0935	25x7 - 5°	Light Blue
03.22.10.0936	25x8 - 5°	Dark Brown
03.22.10.0937	25x9 - 5°	Violet
03.22.10.0938	25x10 - 5°	Silver
03.22.10.0939	25x11 - 5°	Gold
03.22.10.0940	25x12 - 5°	Orange
03.22.10.0941	25x13 - 5°	Dark Blue
03.22.10.0942	25x14 - 5°	Pink
03.22.10.0943	25x15 - 5°	Dark Green
03.22.10.0944	25x9 - 10°	Violet
03.22.10.0945	25x10 - 10°	Silver
03.22.10.0946	25x11 - 10°	Gold
03.22.10.0947	25x12 - 10°	Orange
03.22.10.0948	25x13 - 10°	Dark Blue
03.22.10.0949	25x14 - 10°	Pink
03.22.10.0950	25x15 - 10°	Dark Green

\*Special order / request / special forecast



## MECTALIF OBLIQUE TRIAL



REFERENCE	SIZE(MM) - LORDOSIS(°)	COLOR
03.22.10.0241	25x7 - 0°	Light Blue
03.22.10.0242	25x8 - 0°	Dark Brown
03.22.10.0243*	25x9 - 0°	Violet
03.22.10.0244*	25x10 - 0°	Silver
03.22.10.0245*	25x11 - 0°	Gold
03.22.10.0246*	25x12 - 0°	Orange
03.22.10.0247*	25x13 - 0°	Dark Blue
03.22.10.0248*	25x14 - 0°	Pink
03.22.10.0249*	25x15 - 0°	Dark Green
03.22.10.0250	25x7 - 5°	Light Blue
03.22.10.0251	25x8 - 5°	Dark Brown
03.22.10.0252	25x9 - 5°	Violet
03.22.10.0253	25x10 - 5°	Silver
03.22.10.0254	25x11 - 5°	Gold
03.22.10.0255	25x12 - 5°	Orange
03.22.10.0256	25x13 - 5°	Dark Blue
03.22.10.0257	36x12 - 10°	Orange
03.22.10.0258	36x13 - 10°	Dark Blue
03.22.10.0259	36x14 - 10°	Pink
03.22.10.0260	36x15 - 10°	Dark Green
03.22.10.0216*	28x11 - 10°	Gold

\*Special order / request / special forecast

**MECTALIF POSTERIOR PEEK 11MM**

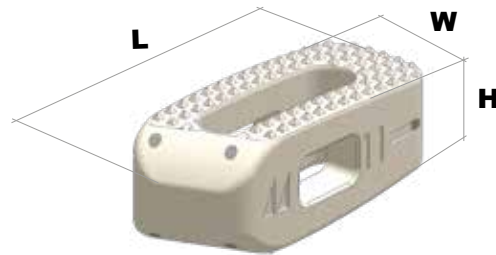

REFERENCE	SIZE(MM) - LORDOSIS(°)	COLOR
03.21.001*	11x22x7	0°
03.21.029*	11x22x8	0°
03.21.002*	11x22x9	0°
03.21.030*	11x22x10	0°
03.21.003*	11x22x11	0°
03.21.031*	11x22x12	0°
03.21.004*	11x22x13	0°
03.21.032*	11x22x14	0°
03.21.005*	11x22x15	0°
03.21.006	11x22x7	5°
03.21.033	11x22x8	5°
03.21.007	11x22x9	5°
03.21.034	11x22x10	5°
03.21.008	11x22x11	5°
03.21.035	11x22x12	5°
03.21.009	11x22x13	5°
03.21.036	11x22x14	5°
03.21.010	11x22x15	5°
03.21.011	11x22x9	10°
03.21.037	11x22x10	10°
03.21.012	11x22x11	10°
03.21.038	11x22x12	10°
03.21.013	11x22x13	10°
03.21.039	11x22x14	10°
03.21.014	11x22x15	10°

REFERENCE	SIZE(MM) - LORDOSIS(°)	COLOR
03.21.015*	11x25x7	0°
03.21.040*	11x25x8	0°
03.21.016*	11x25x9	0°
03.21.041*	11x25x10	0°
03.21.042*	11x25x12	0°
03.21.017*	11x25x11	0°
03.21.018*	11x25x13	0°
03.21.043*	11x25x14	0°
03.21.019*	11x25x15	0°
03.21.020	11x25x7	5°
03.21.044	11x25x8	5°
03.21.021	11x25x9	5°
03.21.045	11x25x10	5°
03.21.022	11x25x11	5°
03.21.046	11x25x12	5°
03.21.023	11x25x13	5°
03.21.047	11x25x14	5°
03.21.024	11x25x15	5°
03.21.025	11x25x9	10°
03.21.048	11x25x10	10°
03.21.026	11x25x11	10°
03.21.049	11x25x12	10°
03.21.027	11x25x13	10°
03.21.050	11x25x14	10°
03.21.028	11x25x15	10°

\*Special order / request / special forecast

## MECTALIF POSTERIOR PEEK 9MM

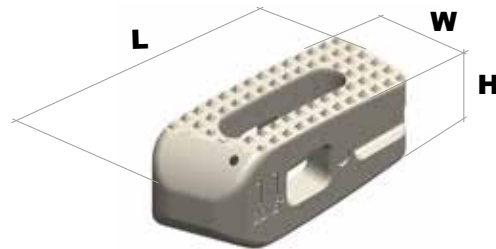

REFERENCE	SIZE(MM) - LORDOSIS(°)	COLOR
03.21.101*	9x22x7	0°
03.21.102*	9x22x8	0°
03.21.103*	9x22x9	0°
03.21.104*	9x22x10	0°
03.21.105*	9x22x11	0°
03.21.106*	9x22x12	0°
03.21.107*	9x22x13	0°
03.21.108*	9x22x14	0°
03.21.109*	9x22x15	0°
03.21.110	9x22x7	5°
03.21.111	9x22x8	5°
03.21.112	9x22x9	5°
03.21.113	9x22x10	5°
03.21.114	9x22x11	5°
03.21.115	9x22x12	5°
03.21.116	9x22x13	5°
03.21.117	9x22x14	5°
03.21.118	9x22x15	5°
03.21.119	9x22x9	10°
03.21.120	9x22x10	10°
03.21.121	9x22x11	10°
03.21.122	9x22x12	10°
03.21.123	9x22x13	10°
03.21.124	9x22x14	10°
03.21.125	9x22x15	10°

REFERENCE	SIZE(MM) - LORDOSIS(°)	COLOR
03.21.126*	9x25x7	0°
03.21.127*	9x25x8	0°
03.21.128*	9x25x9	0°
03.21.129*	9x25x10	0°
03.21.130*	9x25x12	0°
03.21.131*	9x25x11	0°
03.21.132*	9x25x13	0°
03.21.133*	9x25x14	0°
03.21.134*	9x25x15	0°
03.21.135	9x25x7	5°
03.21.136	9x25x8	5°
03.21.137	9x25x9	5°
03.21.138	9x25x10	5°
03.21.139	9x25x11	5°
03.21.140	9x25x12	5°
03.21.141	9x25x13	5°
03.21.142	9x25x14	5°
03.21.143	9x25x15	5°
03.21.144	9x25x9	10°
03.21.145	9x25x10	10°
03.21.146	9x25x11	10°
03.21.147	9x25x12	10°
03.21.148	9x25x13	10°
03.21.149	9x25x14	10°
03.21.150	9x25x15	10°

\*Special order / request / special forecast

**MECTALIF POSTERIOR TIPEEK 11MM**

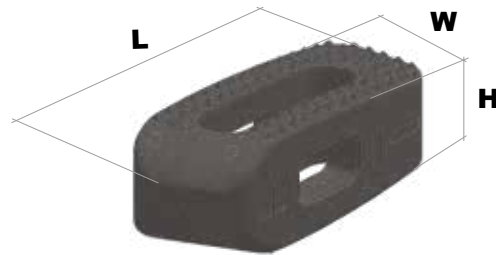

REFERENCE	SIZE(MM) - LORDOSIS(°)	COLOR
03.27.001*	11x22x7	0°
03.27.029*	11x22x8	0°
03.27.002*	11x22x9	0°
03.27.030*	11x22x10	0°
03.27.003*	11x22x11	0°
03.27.031*	11x22x12	0°
03.27.004*	11x22x13	0°
03.27.032*	11x22x14	0°
03.27.005*	11x22x15	0°
03.27.006	11x22x7	5°
03.27.033	11x22x8	5°
03.27.007	11x22x9	5°
03.27.034	11x22x10	5°
03.27.008	11x22x11	5°
03.27.035	11x22x12	5°
03.27.009	11x22x13	5°
03.27.036	11x22x14	5°
03.27.010	11x22x15	5°
03.27.011	11x22x9	10°
03.27.037	11x22x10	10°
03.27.012	11x22x11	10°
03.27.038	11x22x12	10°
03.27.013	11x22x13	10°
03.27.039	11x22x14	10°
03.27.014	11x22x15	10°

REFERENCE	SIZE(MM) - LORDOSIS(°)	COLOR
03.27.015*	11x25x7	0°
03.27.040*	11x25x8	0°
03.27.016*	11x25x9	0°
03.27.041*	11x25x10	0°
03.27.042*	11x25x12	0°
03.27.017*	11x25x11	0°
03.27.018*	11x25x13	0°
03.27.043*	11x25x14	0°
03.27.019*	11x25x15	0°
03.27.020	11x25x7	5°
03.27.044	11x25x8	5°
03.27.021	11x25x9	5°
03.27.045	11x25x10	5°
03.27.022	11x25x11	5°
03.27.046	11x25x12	5°
03.27.023	11x25x13	5°
03.27.047	11x25x14	5°
03.27.024	11x25x15	5°
03.27.025	11x25x9	10°
03.27.048	11x25x10	10°
03.27.026	11x25x11	10°
03.27.049	11x25x12	10°
03.27.027	11x25x13	10°
03.27.050	11x25x14	10°
03.27.028	11x25x15	10°

\*Special order / request / special forecast

## MECTALIF POSTERIOR TIPEEK 9MM

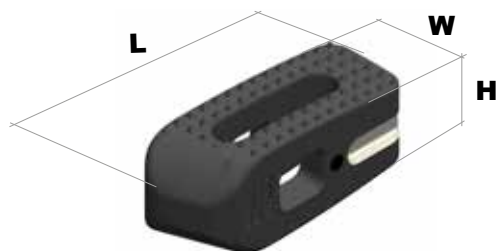

REFERENCE	SIZE(MM) - LORDOSIS(°)	COLOR
03.27.101*	9x22x7	0°
03.27.102*	9x22x8	0°
03.27.103*	9x22x9	0°
03.27.104*	9x22x10	0°
03.27.105*	9x22x11	0°
03.27.106*	9x22x12	0°
03.27.107*	9x22x13	0°
03.27.108*	9x22x14	0°
03.27.109*	9x22x15	0°
03.27.110	9x22x7	5°
03.27.111	9x22x8	5°
03.27.112	9x22x9	5°
03.27.113	9x22x10	5°
03.27.114	9x22x11	5°
03.27.115	9x22x12	5°
03.27.116	9x22x13	5°
03.27.117	9x22x14	5°
03.27.118	9x22x15	5°
03.27.119	9x22x9	10°
03.27.120	9x22x10	10°
03.27.121	9x22x11	10°
03.27.122	9x22x12	10°
03.27.123	9x22x13	10°
03.27.124	9x22x14	10°
03.27.125	9x22x15	10°

REFERENCE	SIZE(MM) - LORDOSIS(°)	COLOR
03.27.126*	9x25x7	0°
03.27.127*	9x25x8	0°
03.27.128*	9x25x9	0°
03.27.129*	9x25x10	0°
03.27.130*	9x25x11	0°
03.27.131*	9x25x12	0°
03.27.132*	9x25x13	0°
03.27.133*	9x25x14	0°
03.27.134*	9x25x15	0°
03.27.135	9x25x7	5°
03.27.136	9x25x8	5°
03.27.137	9x25x9	5°
03.27.138	9x25x10	5°
03.27.139	9x25x11	5°
03.27.140	9x25x12	5°
03.27.141	9x25x13	5°
03.27.142	9x25x14	5°
03.27.143	9x25x15	5°
03.27.144	9x25x9	10°
03.27.145	9x25x10	10°
03.27.146	9x25x11	10°
03.27.147	9x25x12	10°
03.27.148	9x25x13	10°
03.27.149	9x25x14	10°
03.27.150	9x25x15	10°

\*Special order / request / special forecast

**MECTALIF OBLIQUE PEEK**

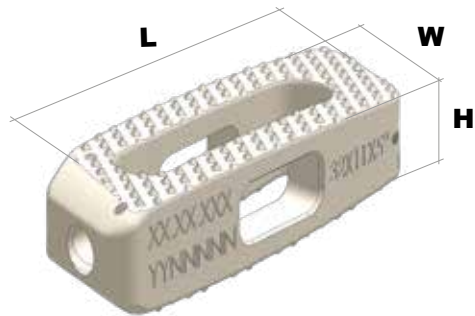

REFERENCE	SIZE(MM) - LORDOSIS(°)	COLOR
03.20.034	12x28x7	0°
03.20.035	12x28x8	0°
03.20.036*	12x28x9	0°
03.20.037*	12x28x10	0°
03.20.038*	12x28x11	0°
03.20.039*	12x28x12	0°
03.20.040*	12x28x13	0°
03.20.041*	12x28x14	0°
03.20.042*	12x28x15	0°
03.20.044	12x28x9	5°
03.20.045	12x28x10	5°
03.20.046	12x28x11	5°
03.20.047	12x28x12	5°
03.20.048	12x28x13	5°
03.20.049	12x28x14	5°
03.20.050	12x28x15	5°
03.20.051	12x28x11	10°
03.20.052	12x28x12	10°
03.20.053	12x28x13	10°
03.20.054	12x28x14	10°
03.20.055	12x28x15	10°
03.20.001	12x32x7	0°
03.20.078	12x32x8	0°
03.20.002*	12x32x9	0°
03.20.079*	12x32x10	0°
03.20.003*	12x32x11	0°
03.20.080*	12x32x12	0°
03.20.004*	12x32x13	0°
03.20.081*	12x32x14	0°
03.20.005*	12x32x15	0°

REFERENCE	SIZE(MM) - LORDOSIS(°)	COLOR
03.20.006	12x32x9	5°
03.20.082	12x32x10	5°
03.20.007	12x32x11	5°
03.20.083	12x32x12	5°
03.20.008	12x32x13	5°
03.20.084	12x32x14	5°
03.20.009	12x32x15	5°
03.20.085	12x32x12	10°
03.20.010	12x32x13	10°
03.20.086	12x32x14	10°
03.20.011	12x32x15	10°
03.20.012	12x36x7	0°
03.20.107	12x36x8	0°
03.20.013*	12x36x9	0°
03.20.108*	12x36x10	0°
03.20.014*	12x36x11	0°
03.20.109*	12x36x12	0°
03.20.015*	12x36x13	0°
03.20.110*	12x36x14	0°
03.20.016*	12x36x15	0°
03.20.017	12x36x9	5°
03.20.111	12x36x10	5°
03.20.018	12x36x11	5°
03.20.112	12x36x12	5°
03.20.019	12x36x13	5°
03.20.113	12x36x14	5°
03.20.020	12x36x15	5°
03.20.114	12x36x12	10°
03.20.021	12x36x13	10°
03.20.115	12x36x14	10°
03.20.022	12x36x15	10°

\*Special order / request / special forecast

## MECTALIF OBLIQUE TIPEEK

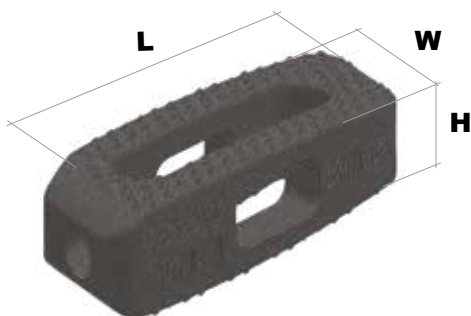

REFERENCE	SIZE(MM) - LORDOSIS(°)	COLOR
03.26.034	12x28x7	0°
03.26.035	12x28x8	0°
03.26.036*	12x28x9	0°
03.26.037*	12x28x10	0°
03.26.038*	12x28x11	0°
03.26.039*	12x28x12	0°
03.26.040*	12x28x13	0°
03.26.041*	12x28x14	0°
03.26.042*	12x28x15	0°
03.26.044	12x28x9	5°
03.26.045	12x28x10	5°
03.26.046	12x28x11	5°
03.26.047	12x28x12	5°
03.26.048	12x28x13	5°
03.26.049	12x28x14	5°
03.26.050	12x28x15	5°
03.26.051	12x28x11	10°
03.26.052	12x28x12	10°
03.26.053	12x28x13	10°
03.26.054	12x28x14	10°
03.26.055	12x28x15	10°
03.26.001	12x32x7	0°
03.26.078	12x32x8	0°
03.26.002*	12x32x9	0°
03.26.079*	12x32x10	0°
03.26.003*	12x32x11	0°
03.26.080*	12x32x12	0°
03.26.004*	12x32x13	0°
03.26.081*	12x32x14	0°
03.26.005*	12x32x15	0°

REFERENCE	SIZE(MM) - LORDOSIS(°)	COLOR
03.26.006	12x32x9	5°
03.26.082	12x32x10	5°
03.26.007	12x32x11	5°
03.26.083	12x32x12	5°
03.26.008	12x32x13	5°
03.26.084	12x32x14	5°
03.26.009	12x32x15	5°
03.26.085	12x32x12	10°
03.26.010	12x32x13	10°
03.26.086	12x32x14	10°
03.26.011	12x32x15	10°
03.26.012	12x36x7	0°
03.26.107	12x36x8	0°
03.26.013*	12x36x9	0°
03.26.108*	12x36x10	0°
03.26.014*	12x36x11	0°
03.26.109*	12x36x12	0°
03.26.015*	12x36x13	0°
03.26.110*	12x36x14	0°
03.26.016*	12x36x15	0°
03.26.017	12x36x9	5°
03.26.111	12x36x10	5°
03.26.018	12x36x11	5°
03.26.112	12x36x12	5°
03.26.019	12x36x13	5°
03.26.113	12x36x14	5°
03.26.020	12x36x15	5°
03.26.114	12x36x12	10°
03.26.021	12x36x13	10°
03.26.115	12x36x14	10°
03.26.022	12x36x15	10°

\*Special order / request / special forecast

**9. RECOMMENDED FIXATION OPTIONS**

Supplemental internal fixation e.g. pedicle screw fixation must be applied.







Part numbers subject to change.

## **NOTE FOR STERILIZATION**

The instrumentation is not sterile upon delivery. Instruments must be cleaned before use and sterilized in an autoclave respecting the US regulations, directives where applicable, and following the manufactures instructions for use of the autoclave. For detailed instructions please refer to the document "Recommendations for cleaning decontamination and sterilisation of Medacta International orthopaedic devices" available at [www.medacta.com](http://www.medacta.com).



---

**REDEFINING BETTER  
IN ORTHOPAEDICS  
AND NEUROSURGERY**

---

MEDACTA.COM



**Medacta International SA**  
Strada Regina - 6874 Castel San Pietro - Switzerland  
Phone +41 91 696 60 60 - Fax +41 91 696 60 66  
info@medacta.ch

Find your local dealer at: [medacta.com/locations](http://medacta.com/locations)

All trademarks and registered trademarks are the property of their respective owners.  
This document is intended for the US market.

MectaLIF Oblique & Posterior  
Surgical Technique

ref: 99.44.12US  
rev. 05

Last update: October 2018