

VERSAFITCUP[®] SYSTEM

ELLIPTICAL PRESS-FIT CUP



Instrumentation

Hip

Knee

Spine

Navigation

VERSAFITCUP® SYSTEM - INSTRUMENTATION NOMENCLATURE

This brochure contains the packing lists configurations used in the Versafitcup® System Surgical Technique (ref: 99.16TRIO.12US and ref: 99.16.12US).

The following table summarizes the acceptable combinations to make complete sets of instruments.

Implant Packing list configuration	Implanting only Versafitcup® DM	Implanting only Versafitcup® CC Trio	Implanting Versafitcup® CC Trio and Versafitcup® DM	Implanting Versafitcup® CC Trio and Versafitcup® DM <i>(Upgrade of existing Versafitcup® DM Client)</i>
01.26s.304US Versafitcup® DM General Instruments	✓			
01.26s.307US Versafitcup® CC General Instruments		✓	✓	
01.26s.308US Versafitcup® CC Trial Liners		✓	✓	✓
01.26s.302US Versafitcup® DM Dedicated Instruments	✓		✓	
01.26S.303US Versafitcup® DM Instruments Upgrades				✓

CAUTION

Federal law (USA) restricts this device to sale distribution and use by or on the order of physician.





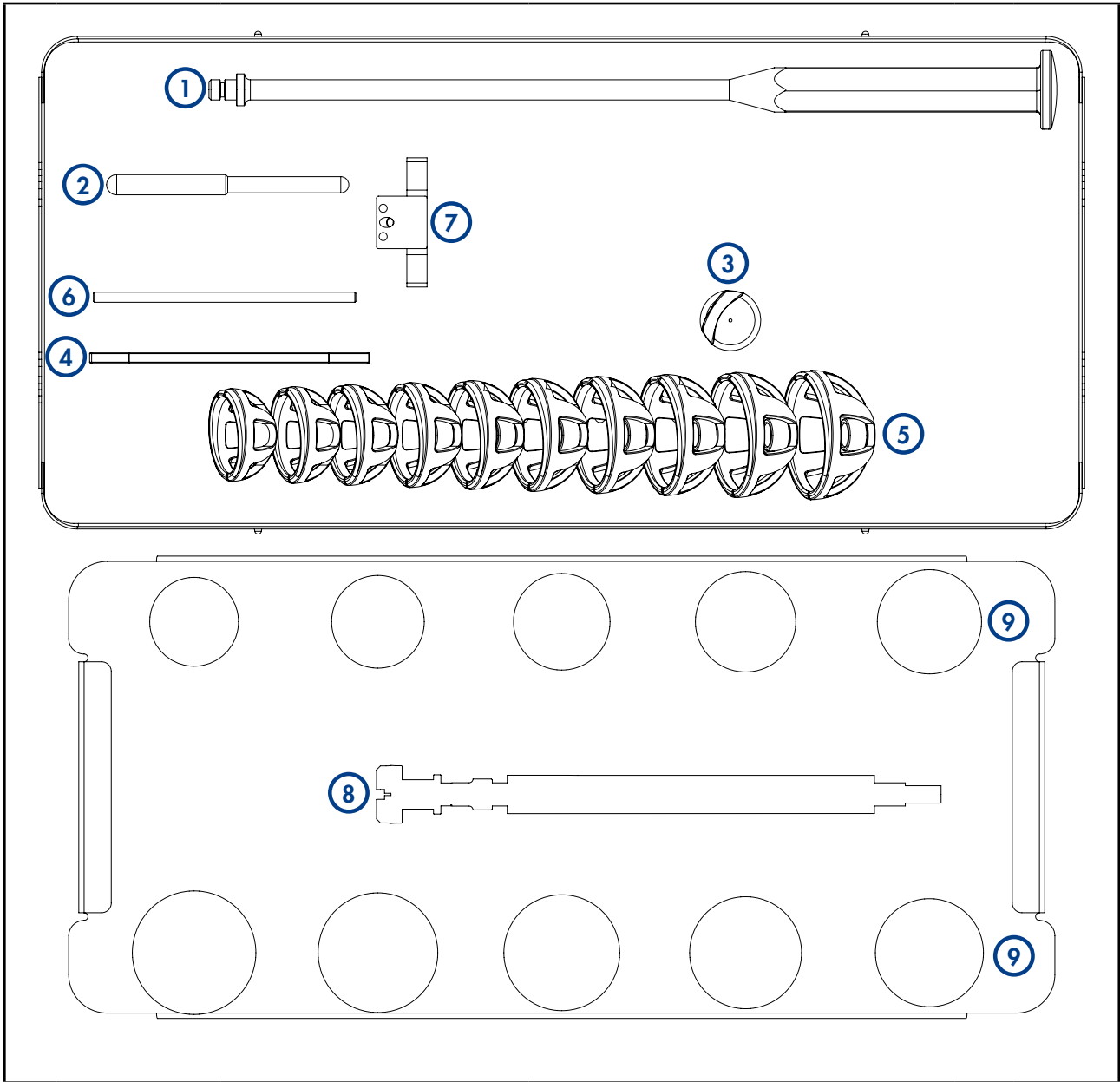

TABLE OF CONTENTS

1	Versafitcup® DM General Instruments	4
2	Versafitcup® CC General Instruments	6
3	Versafitcup® CC Trial Liners	9
4	Versafitcup® DM Dedicated Instruments	10
5	Versafitcup® DM Instruments Upgrades	13

Ref. 01.26S.304US - Versafitcup® DM General Instruments



N.	Ref.	Description	Qty.	Status
1	01.26.10.0001	Short multifunction handle	1	on demand
	01.26.10.0162	Long multifunction handle	1	✓
2	01.26.10.0063	Rod for multifunction handle	1	✓

N.	Ref.	Description		Qty.	Status
3	01.26.10.0075	Acetabular shell correction impactor		1	✓
4	01.26.10.0150	Release key for impaction washer		1	✓
5	01.26.10.0020	Trial cup Ø 46 mm		1	✓
	01.26.10.0021	Trial cup Ø 48 mm			
	01.26.10.0022	Trial cup Ø 50 mm			
	01.26.10.0023	Trial cup Ø 52 mm			
	01.26.10.0024	Trial cup Ø 54 mm			
	01.26.10.0025	Trial cup Ø 56 mm			
	01.26.10.0026	Trial cup Ø 58 mm			
	01.26.10.0027	Trial cup Ø 60 mm			
	01.26.10.0028	Trial cup Ø 62 mm			
01.26.10.0029	Trial cup Ø 64 mm				
6	01.04.10.0012	Rod for orientation guide		2	✓
7	33.22.0066	Orientation guide		1	✓
8	01.26.10.0102	EZ-Clean Reamer Handle Stryker/ Zimmer-Hall		2	✓
	01.26.211	EZ-Clean Reamer handle - Hudson		1	on demand
9	01.30.10.3140	Acetabular reamer Ø 40 mm		1	on demand
	01.30.10.3142	Acetabular reamer Ø 42 mm			
	01.30.10.3144	Acetabular reamer Ø 44 mm			
	01.30.10.3146	Acetabular reamer Ø 46 mm			
	01.30.10.3148	Acetabular reamer Ø 48 mm			
	01.30.10.3150	Acetabular reamer Ø 50 mm			
	01.30.10.3152	Acetabular reamer Ø 52 mm			
	01.30.10.3154	Acetabular reamer Ø 54 mm			
	01.30.10.3156	Acetabular reamer Ø 56 mm			
	01.30.10.3158	Acetabular reamer Ø 58 mm			
	01.30.10.3160	Acetabular reamer Ø 60 mm			
	01.30.10.3162	Acetabular reamer Ø 62 mm			
	01.30.10.3164	Acetabular reamer Ø 64 mm			
	01.26.10.0400	Empty tray		1	✓
	02.02.10.0412	External tray for sterilisation		1	on demand

Ref. 01.26S.307US - Versafitcup® CC General Instruments

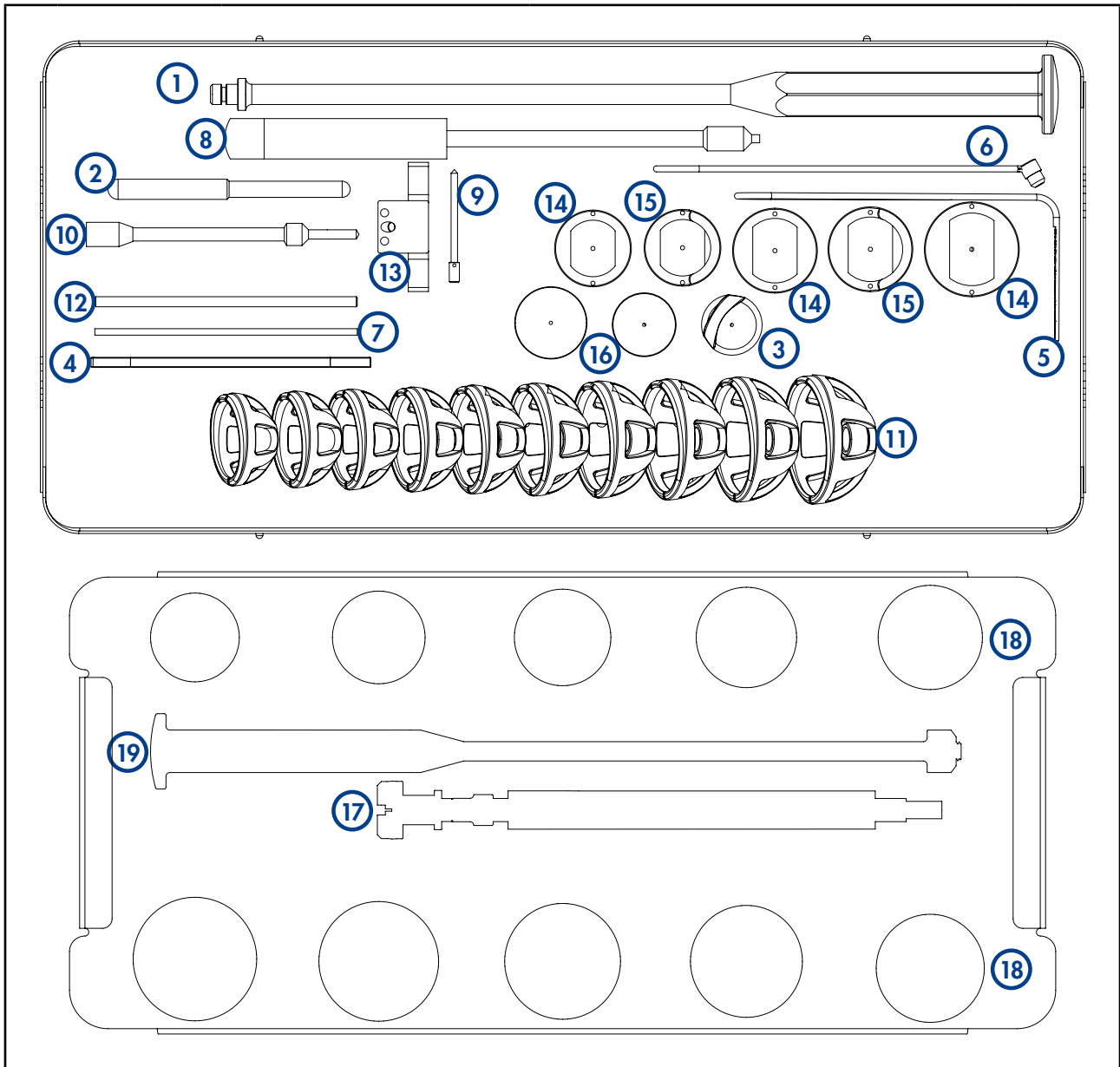

N.	Ref.	Description	Qty.	Status
1	01.26.10.0001	Short multifunction handle	1	on demand
	01.26.10.0162	Long multifunction handle	1	✓
2	01.26.10.0063	Rod for multifunction handle	1	✓
3	01.26.10.0075	Acetabular shell correction impactor	1	✓

N.	Ref.	Description		Qty.	Status
4	01.26.10.0150	Release key for impaction washer		1	✓
5	01.26.10.0068	Hooked depth gauge		1	✓
6	T16014	Drill guide Ø 3.2 mm		1	✓
7	02.02.10.0130	Drill bit Ø 3.2 mm L 130 mm		1	✓
8	01.26.10.0011	Cardan hex-head screwdrivers 3.5 mm		1	✓
9	01.26.10.0012	Bayonet drill Ø 3.2 mm L 56 mm		1	✓
10	01.26.10.0013	Flexible bayonet drill holder		1	✓
11	01.26.10.0123	Trial Cup Ø 42 mm		1	on demand
	01.26.10.0124	Trial Cup Ø 44 mm		1	on demand
	01.26.10.0020	Trial Cup Ø 46 mm		1	✓
	01.26.10.0021	Trial Cup Ø 48 mm			
	01.26.10.0022	Trial Cup Ø 50 mm			
	01.26.10.0023	Trial Cup Ø 52 mm			
	01.26.10.0024	Trial Cup Ø 54 mm			
	01.26.10.0025	Trial Cup Ø 56 mm			
	01.26.10.0026	Trial Cup Ø 58 mm			
	01.26.10.0027	Trial Cup Ø 60 mm			
01.26.10.0028	Trial Cup Ø 62 mm				
01.26.10.0029	Trial Cup Ø 64 mm				
12	01.04.10.0012	Rod for orientation guide		2	on demand
13	33.22.0066	Orientation guide		1	on demand
14	01.26.10.0090	Impaction washer for flat liner UHMWPE Ø 28 mm		1	✓
	01.26.10.0091	Impaction washer for flat liner UHMWPE Ø 32 mm			
	01.26.10.0092	Impaction washer for flat liner UHMWPE Ø 36 mm			
15	01.26.10.0093	Impaction washer for hooded liner UHMWPE Ø 28 mm		1	✓
	01.26.10.0094	Impaction washer for hooded liner UHMWPE Ø 32 mm			
16	01.26.10.0087	Liner impaction sphere Ø 22 mm		1	on demand
	01.26.10.0095	Liner impaction sphere Ø 28 mm		1	on demand
	01.26.10.0098	Liner impaction sphere Ø 32 mm		1	✓
	01.26.10.0099	Liner impaction sphere Ø 36 mm		1	✓
17	01.26.10.0102	EZ-Clean Reamer Handle Stryker/ Zimmer-Hall		2	✓

N.	Ref.	Description	Qty.	Status
18	01.30.10.3140	Acetabular reamer Ø 40 mm	1	on demand
	01.30.10.3142	Acetabular reamer Ø 42 mm		✓
	01.30.10.3144	Acetabular reamer Ø 44 mm		
	01.30.10.3146	Acetabular reamer Ø 46 mm		
	01.30.10.3148	Acetabular reamer Ø 48 mm		
	01.30.10.3150	Acetabular reamer Ø 50 mm		
	01.30.10.3152	Acetabular reamer Ø 52 mm		
	01.30.10.3154	Acetabular reamer Ø 54 mm		
	01.30.10.3156	Acetabular reamer Ø 56 mm		
	01.30.10.3158	Acetabular reamer Ø 58 mm		
	01.30.10.3160	Acetabular reamer Ø 60 mm		
	01.30.10.3162	Acetabular reamer Ø 62 mm		
01.30.10.3164	Acetabular reamer Ø 64 mm			
19	01.26.10.0062	Impactor handle	1	✓
	01.26.10.0059	Hexagonal head screwdriver L 350 mm	1	on demand
	01.26.10.0279	Versafitcup® CC Family Templates 100%	1	on demand
	01.26.10.0280	Versafitcup® CC Family Templates 110%	1	on demand
	01.26.10.0281	Versafitcup® CC Family Templates 115%	1	✓
	01.26.10.0282	Versafitcup® CC Family Templates 120%	1	on demand
	01.26.10.0400	Empty tray	1	✓
	02.02.10.0412	External tray for sterilisation	1	on demand



Ref. 01.26S.308US - Versafitcup® CC Trial Liners

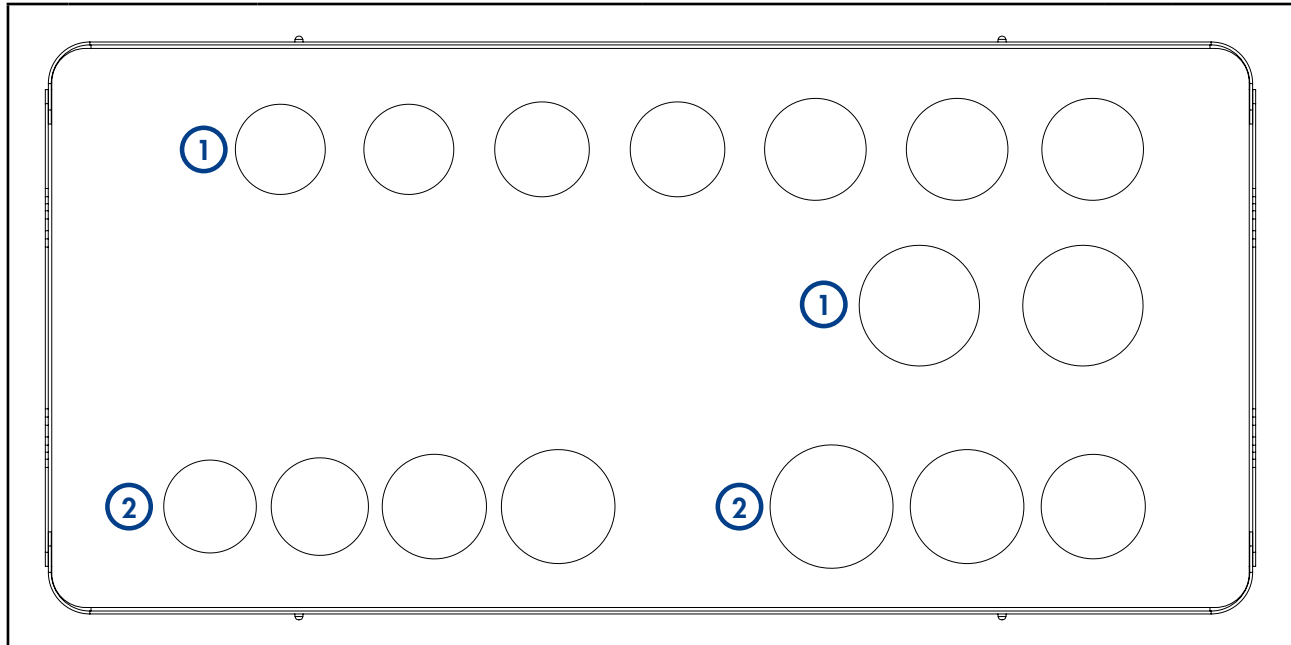



N.	Ref.	Description	Qty.	Status	
1	01.26.10.0198	Flat Trial Liner Ø 22 / AZ (Magenta)	1	on demand	
	01.26.10.0199	Flat Trial Liner Ø 28 / B (Brown)	1	on demand	
	01.26.10.0200	Flat Trial Liner Ø 28 / C (Red)		1	✓
	01.26.10.0211	Flat Trial Liner Ø 32 / C (Red)			
	01.26.10.0202	Flat Trial Liner Ø 28 / E (Blue)			
	01.26.10.0203	Flat Trial Liner Ø 32 / E (Blue)			
	01.26.10.0212	Flat Trial Liner Ø 36 / E (Blue)			
	01.26.10.0204	Flat Trial Liner Ø 28 / F (Black)			
	01.26.10.0205	Flat Trial Liner Ø 32 / F (Black)			
	01.26.10.0206	Flat Trial Liner Ø 36 / F (Black)			
	01.26.10.0207	Flat Trial Liner Ø 28 / G (Green)			
	01.26.10.0208	Flat Trial Liner Ø 32 / G (Green)			
	01.26.10.0209	Flat Trial Liner Ø 36 / G (Green)			
2	01.26.10.0194	Hooded Trial Liner Ø 22 / AZ (Magenta)	1	on demand	
	01.26.10.0195	Hooded Trial Liner Ø 28 / B (Brown)	1	on demand	
	01.26.10.0220	Hooded Trial Liner Ø 28 / C (Red)		1	✓
	01.26.10.0222	Hooded Trial Liner Ø 28 / E (Blue)			
	01.26.10.0223	Hooded Trial Liner Ø 32 / E (Blue)			
	01.26.10.0224	Hooded Trial Liner Ø 28 / F (Black)			
	01.26.10.0225	Hooded Trial Liner Ø 32 / F (Black)			
	01.26.10.0226	Hooded Trial Liner Ø 28 / G (Green)			
	01.26.10.0227	Hooded Trial Liner Ø 32 / G (Green)			

	01.26.10.0402	Empty tray	1	✓
	02.02.10.0413	External tray for sterilisation	1	on demand

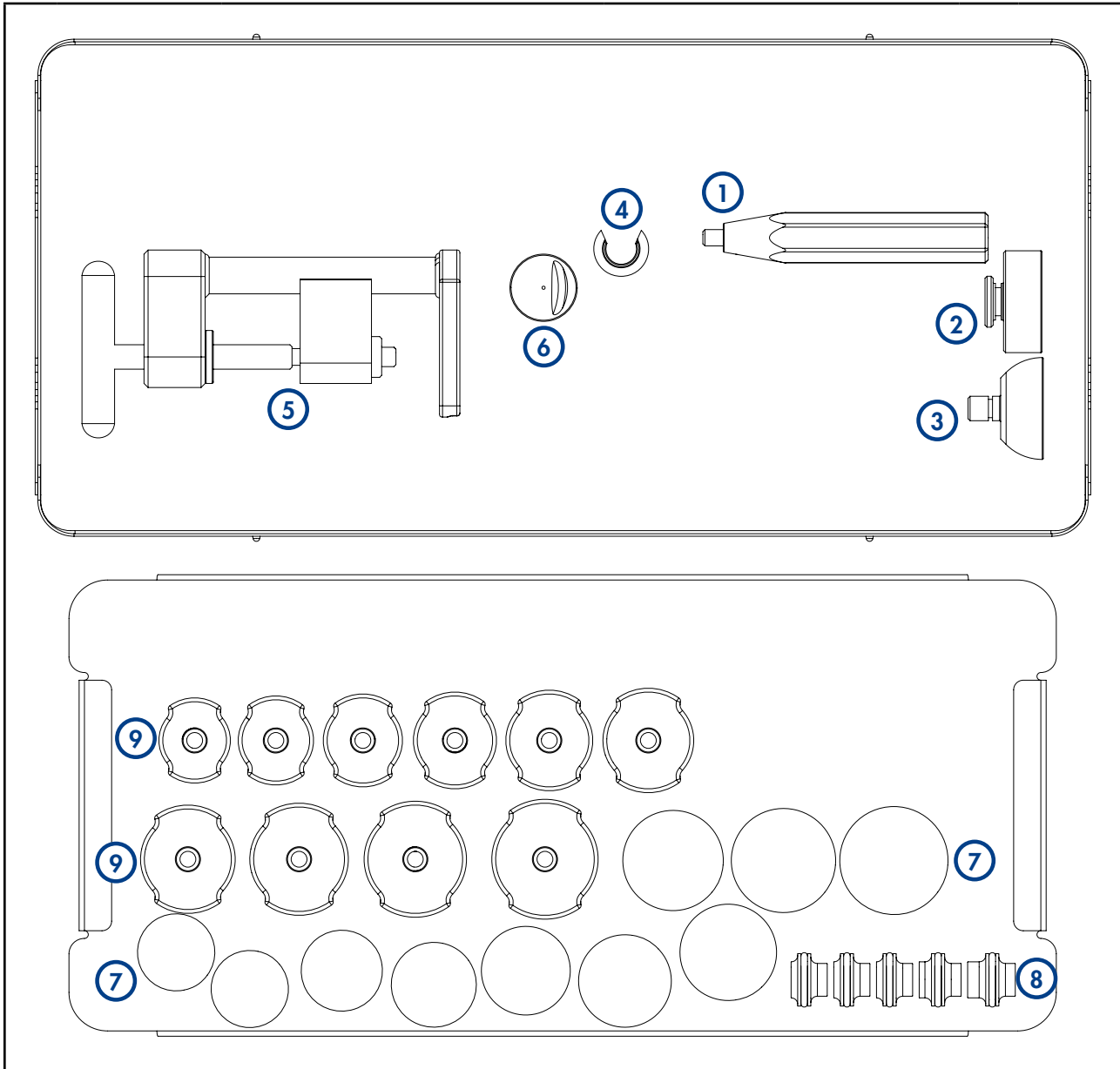
Ref. 01.26S.302US - Versafitcup® DM Dedicated Instruments



N.	Ref.	Description		Qty.	Status
1	01.26.10.0064	Handle for double mobility liner inserter		1	✓
2	01.26.10.0065	Cups adaptor for double mobility liner inserter		1	✓
3	01.26.10.0066	Double mobility liner adaptor		1	✓







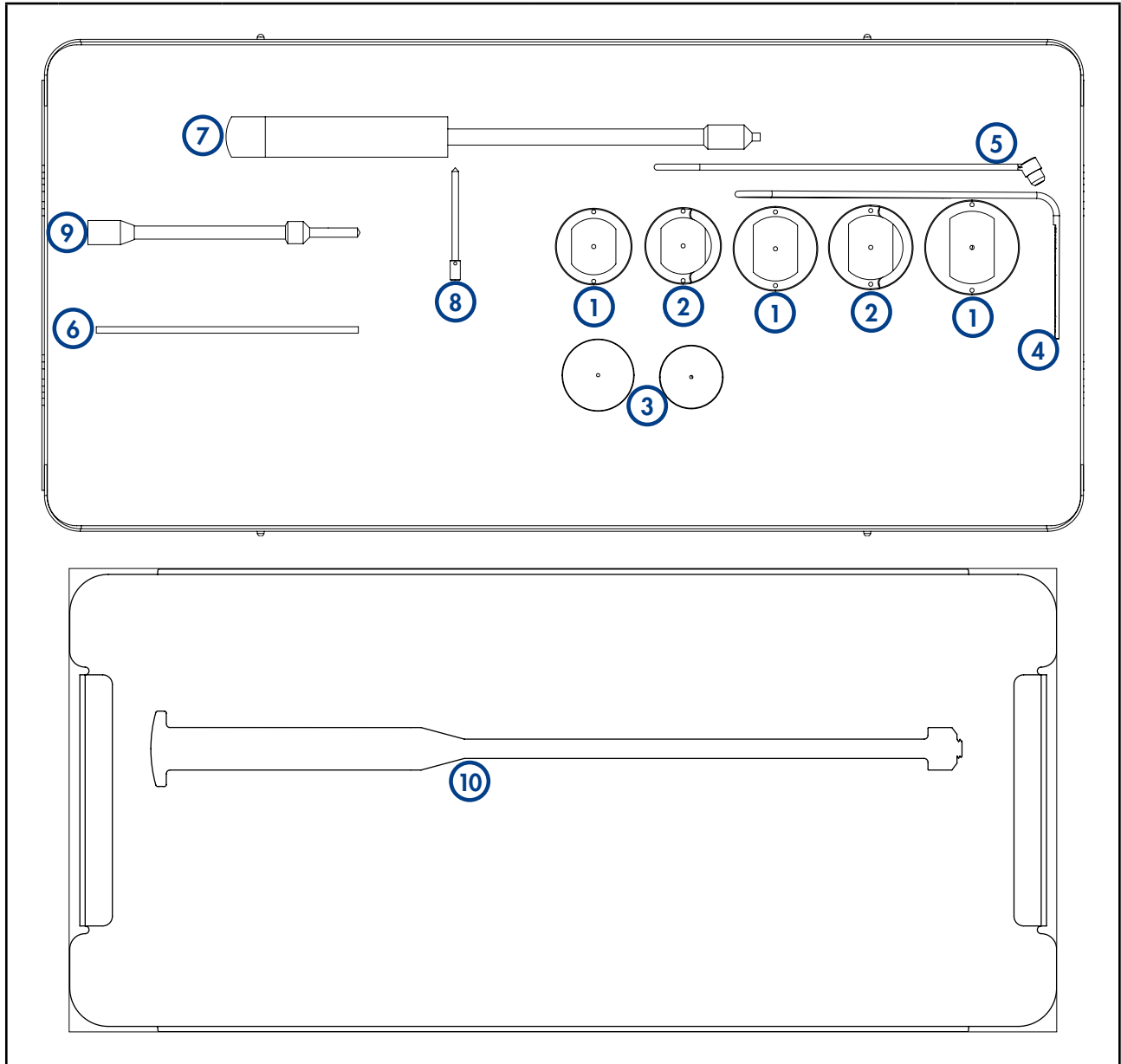





N.	Ref.	Description		Qty.	Status
4	01.26.10.0067	Stem support for double mobility liner inserter		1	✓
5	01.26.10.0018	Double mobility liner inserter		1	✓
6	01.26.10.0017	Correction impaction sphere Ø 33 mm for acetabular shell		1	✓
7	01.26.10.0230	Modular trial mobile liner DMC		1	✓
	01.26.10.0231	Modular trial mobile liner DMD			
	01.26.10.0232	Modular trial mobile liner DME			
	01.26.10.0233	Modular trial mobile liner DMF			
	01.26.10.0234	Modular trial mobile liner DMG			
	01.26.10.0235	Modular trial mobile liner DMH			
	01.26.10.0236	Modular trial mobile liner DMI			
	01.26.10.0237	Modular trial mobile liner DML			
	01.26.10.0238	Modular trial mobile liner DMM			
	01.26.10.0239	Modular trial mobile liner DMN			
8	01.26.10.0240	Trial Adapter Small (Green)		1	✓
	01.26.10.0241	Trial Adapter Medium (Yellow)			
	01.26.10.0242	Trial Adapter Large (Red)			
	01.26.10.0243	Trial Adapter Extra Large (Blue)			
	01.26.10.0244	Trial Adapter Extra Extra Large (Gray)			
	01.25.10.005	Trial extractor		1	✓
9	01.26.10.0133	Impacting ring Ø 46 mm		1	✓
	01.26.10.0134	Impacting ring Ø 48 mm			
	01.26.10.0135	Impacting ring Ø 50 mm			
	01.26.10.0136	Impacting ring Ø 52 mm			
	01.26.10.0137	Impacting ring Ø 54 mm			
	01.26.10.0138	Impacting ring Ø 56 mm			
	01.26.10.0139	Impacting ring Ø 58 mm			
	01.26.10.0140	Impacting ring Ø 60 mm			
	01.26.10.0141	Impacting ring Ø 62 mm			
	01.26.10.0142	Impacting ring Ø 64 mm			

N.	Ref.	Description	Qty.	Status
	01.26.10.0033	Trial double mobility liner Ø 22mm / DMC	1	on demand
	01.26.10.0034	Trial double mobility liner Ø 22mm / DMD		
	01.26.10.0035	Trial double mobility liner Ø 28mm / DMD		
	01.26.10.0036	Trial double mobility liner Ø 28mm / DME		
	01.26.10.0037	Trial double mobility liner Ø 28mm / DMF		
	01.26.10.0038	Trial double mobility liner Ø 28mm / DMG		
	01.26.10.0039	Trial double mobility liner Ø 28mm / DMH		
	01.26.10.0040	Trial double mobility liner Ø 28mm / DMI		
	01.26.10.0041	Trial double mobility liner Ø 28mm / DML		
	01.26.10.0042	Trial double mobility liner Ø 28mm / DMM		
	01.26.10.0043	Trial double mobility liner Ø 28mm / DMN		
	01.26.10.0155	Impaction washer Ø 22 mm / Ø 46-48 mm	1	on demand
	01.26.10.0156	Impaction washer Ø 28 mm / Ø 48 mm	1	on demand
	01.26.10.0157	Impaction washer Ø 28 mm / Ø 50>64 mm	1	on demand
	01.26.10.0160	Impactor handle	1	on demand
	01.26.10.0045	Trial Fixed Liner Ø 22mm / Ø 46mm (Green)	1	on demand
	01.26.10.0046	Trial Fixed Liner Ø 22mm / Ø 48mm (Green)		
	01.26.10.0047	Trial Fixed Liner Ø 28mm / Ø 48mm (Black)		
	01.26.10.0048	Trial Fixed Liner Ø 28mm / Ø 50mm (Blue)		
	01.26.10.0049	Trial Fixed Liner Ø 28mm / Ø 52mm (Blue)		
	01.26.10.0050	Trial Fixed Liner Ø 28mm / Ø 54mm (Blue)		
	01.26.10.0051	Trial Fixed Liner Ø 28mm / Ø 56mm (Blue)		
	01.26.10.0052	Trial Fixed Liner Ø 28mm / Ø 58mm (Blue)		
	01.26.10.0053	Trial Fixed Liner Ø 28mm / Ø 60mm (Blue)		
	01.26.10.0054	Trial Fixed Liner Ø 28mm / Ø 62mm (Blue)		
	01.26.10.0055	Trial Fixed Liner Ø 28mm / Ø 64mm (Blue)		
	01.26.10.0379	Versafitcup® DM Templates 100%	1	on demand
	01.26.10.0380	Versafitcup® DM Templates 110%	1	on demand
	01.26.10.0381	Versafitcup® DM Templates 115%	1	✓
	01.26.10.0382	Versafitcup® DM Templates 120%	1	on demand
	01.26.10.0401	Empty tray	1	✓
	02.02.10.0412	External tray for sterilisation	1	on demand

Ref. 01.26S.303US - Versafitcup® DM Instruments Upgrades



N.	Ref.	Description	Qty.	Status
1	01.26.10.0090	Impaction washer for flat liner UHMWPE Ø 28 mm	1	✓
	01.26.10.0091	Impaction washer for flat liner UHMWPE Ø 32 mm		
	01.26.10.0092	Impaction washer for flat liner UHMWPE Ø 36 mm		
2	01.26.10.0093	Impaction washer for hooded liner UHMWPE Ø 28 mm	1	✓
	01.26.10.0094	Impaction washer for hooded liner UHMWPE Ø 32 mm		

N.	Ref.	Description		Qty.	Status
3	01.26.10.0087	Liner impaction sphere Ø 22 mm		1	on demand
	01.26.10.0095	Liner impaction sphere Ø 28 mm		1	on demand
	01.26.10.0098	Liner impaction sphere Ø 32 mm		1	✓
	01.26.10.0099	Liner impaction sphere Ø 36 mm		1	✓
4	01.26.10.0068	Hooked depth gauge		1	✓
5	T16014	Drill guide Ø 3.2 mm		1	✓
6	02.02.10.0130	Drill bit Ø 3.2 mm L 130 mm		1	✓
7	01.26.10.0011	Cardan hex-head screwdrivers 3.5 mm		1	✓
8	01.26.10.0012	Bayonet drill Ø 3.2 mm L 56 mm		1	✓
9	01.26.10.0013	Flexible bayonet drill holder		1	✓
10	01.26.10.0062	Impactor handle		1	✓
	01.26.10.0123	Trial cup Ø 42 mm		1	on demand
	01.26.10.0124	Trial cup Ø 44 mm		1	on demand
	01.15.10.0261	Terminal cup impactor for metal back CC		1	✓
	01.26.10.0059	Hexagonal head screwdriver L 350 mm		1	on demand
	01.26.10.0279	Versafitcup® System Templates 100%		1	on demand
	01.26.10.0280	Versafitcup® System Templates 110%		1	on demand
	01.26.10.0281	Versafitcup® System Templates 115%		1	✓
	01.26.10.0282	Versafitcup® System Templates 120%		1	on demand
	01.26.10.0400	Empty tray		1	✓
	02.02.10.0412	External tray for sterilization		1	on demand

Part numbers subject to change.

NOTE FOR STERILIZATION

Note for sterilization: the instruments are not sterile upon delivery. Instruments must be cleaned before use and sterilized in an autoclave respecting the US regulations, directives where applicable, and following the manufactures instructions for use of the autoclave.

For detailed instructions please refer to the document "Recommendations for cleaning decontamination and sterilization of Medacta® International reusable orthopaedic devices" available at www.medacta.com.

Versafitcup® and Medacta® are registered trademarks of Medacta® International SA, Castel San Pietro, Switzerland.



International



Medacta International SA

Strada Regina - 6874 Castel San Pietro

Switzerland

Phone +41 91 696 60 60

Fax +41 91 696 60 66

info@medacta.ch

DISTRIBUTED BY

Medacta USA

4725 Calle Quetzal Suite B - Camarillo

California 93012

Phone +1 805 437 7085

Fax +1 805 437 7089

info@medacta.us.com